



 elica



# MEET THE CHEF IN YOU.

KITCHENS ARE A SACRED PLACE. TEMPLES OF TASTE WHERE ALONG WITH NOURISHMENT, MANY DELICIOUS STORIES AND TANTALIZING GOSSIPS ARE CONCOCTED, AND DELIVERED WITH LOVE AND PASSION. WHERE SKILL AND TALENT IS WORSHIPPED, BUT THE LACK OF IT NOT PERMITTED.

AT ELICA, WE WORK HARD TO INNOVATE AND INVENT THE FINEST KITCHEN APPLIANCES SO THAT YOU CAN TAKE CONTROL OF YOUR FAMILY'S WHIMS AND DEMANDS, WITHOUT BREAKING A SWEAT. WE OFFER PREMIUM DEVICES THAT EFFICIENTLY, AND EASILY, TURN AN ORDINARY HOME COOK INTO A MASTER CHEF CELEBRATED BY FAMILY AND FRIENDS.

SO MAKE THE BEST OF YOUR KITCHEN, AND YOURSELF. YOUR FAMILY DESERVES IT.

# THE ITALIAN TOUCH. THE PERFECT COMPLEMENT TO AN INDIAN KITCHEN.

IN 2010, ELICA SPA FORMED A JOINT VENTURE, ELICA PB INDIA PRIVATE LIMITED, IN INDIA. LOCATED IN PUNE, MAHARASHTRA, OUR STATE-OF-THE-ART MANUFACTURING PLANT IS WELL-EQUIPPED WITH MACHINERY, ASSEMBLY LINES AND EQUIPMENT IMPORTED FROM ITALY.

ALL THE PRODUCTS ARE ERGONOMICALLY DESIGNED WITH THE HIGHEST DEGREE OF CARE TAKEN TO CHOOSE MATERIAL, ENSURE SAFETY AND SAVE ELECTRIC CONSUMPTION. THE PRODUCTS ARE EASY TO USE, EASY TO INSTALL AND ARE MANUFACTURED USING CUTTING-EDGE TECHNOLOGY. MOREOVER, ELICA KITCHEN APPLIANCES ARE SPECIALLY DESIGNED TO CREATE SILENT KITCHENS AND PLEASANT COOKING EXPERIENCES.

OUR AIM IS TO REVOLUTIONISE THE LIFESTYLE KITCHEN APPLIANCES INDUSTRY IN INDIA, AND OFFER OUR CUSTOMERS THE FINEST KITCHEN APPLIANCES THAT RESPOND TO THE TASTES AND STANDARDS OF THE INDIAN MARKET ENRICHED BY ITALIAN EXPERTISE AND STYLE.



# INDEX

KITCHENHOODS



BUILT-IN HOBS



BUILT-INOVEN/MWO



INDUCTION, FRYER, BARBEQUE



WARMERDRAWER



DISWASHER



COOKINGRANGES



COOKTOPS



# INDEX

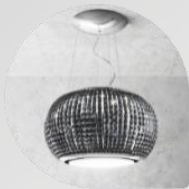

**HI-LIFE**  
KITCHENHOODS



**I-SMART**  
INVERTER KITCHENHOODS

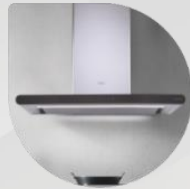

**EDS**  
KITCHENHOODS



**VERTICAL**  
KITCHENHOODS



**FILTERLESS & HAC**  
KITCHENHOODS



**ETB/BAFFLE FILTER**  
KITCHENHOODS



# INDEX



**DFS HOB**  
BUILT-IN HOB/FLEXI HOB-TOP



**PRO HOB**  
BUILT-IN HOB/FLEXI HOB-TOP



**CLASSIC HOB**  
FLEXI HOB-TOP



**DT HOB**  
FLEXI HOB-TOP



**SQUARE GRID HOB**  
FLEXI HOB-TOP

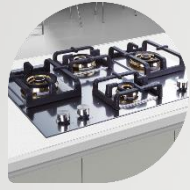

**INOX HOB**  
FLEXI HOB-TOP



# INDEX



BUILT-IN  
OVEN



BUILT-IN  
COMBINATION  
OVEN



BUILT-IN  
MICROWAVE  
OVEN



BUILT-IN  
COMBI PAIRS OF  
OVEN & MWO.



# INDEX



BUILT-IN  
INDUCTION



BUILT-IN  
FRYER



BUILT-IN  
BARBEQUE



# INDEX



TOP KNOB SERIES



SLIMLINE SPF SERIES



PATIO SPF SERIES



DT SERIES



VETRO SERIES



INOX SERIES





Hi-Life  
KITCHENHOODS



NIKOLATESLA

AN UNCONVENTIONAL UNION  
FOR ANYONE WHO LOVES  
THINKING OUTSIDE THE BOX.



The first aspirating hob by Elica, can reach very high performance levels in terms of fume capture, noise level and energy efficiency. Thanks to a direct communication with the hob, Nikola Tesla receives the information coming from the cooking zones and automatically sets ideal aspiration values. Available both in aspiration and filtering mode, the hob has been designed to fit in any type of living space.





NIKOLATESLA



NIKOLATESLA HP



## NIKOLATESLA

- Size:** 83 x 51 x 21 cm  
**Max airflow:** 625 m3/h  
**Filter:** Grease  
**Controls:** 9s + B Touch  
**Finish:** Black Glass  
**Functions:** Touch Control  
 9 Power Level  
 Safety Shut Down  
 Child Lock  
 Timer  
 Power Booster  
 Residual Heat Indicator



HIGH PERFORMANCE REVOLUTION FILTER



STOP&GO POWER LIMITATION

NIKOLATESLA



POSSIBLE INSTALLATIONS



HOME

NIKOLATESLA



"INTELLIGENT SYSTEM"  
IS THE TECHNOLOGY THAT  
ALLOWS THE FUME  
ASPIRATION DEVICE TO  
SELF-ADJUST ACCORDING  
TO THE HOB USAGE



RECYCLING





## DRAFT 90 SS

- Size: 90 cm
- Max airflow: 1100 m<sup>3</sup>/h
- Filter: 1 Aluminium Filter
- Controls: Touch
- Finish: Stainless Steel + Glass
- Lighting: LED 2 x 1 W

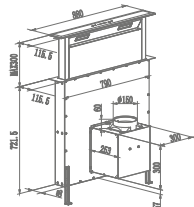

EMPTY SKY

SUSPENDED ELEMENTS,  
PURITY OF SHAPES.



Empty Sky is the first Elica ceiling hood in Cristalplant, designed with a simple gesture: a curve that alters the planarity of the ceiling, creating a slice where air is aspirated from. The innovative hanging polished steel element represents the technological heart of the product. The practical guides in the body of the hood, allow for the opening of the two Cristalplant components, thus making cleaning and maintenance easier. Aspiration is both central and along the perimeter, contributing to maximum aspiration performance and low noise level. Matte white with a velvety effect, accentuates the purity of the shape and the materiality of the product, which stylishly blends in with the style of the kitchen.





RECYCLING VERSION



## EMPTY SKY

**Size:** 120 x 70 cm  
**Max airflow:** 559-823 m<sup>3</sup>/h  
**Filter:** Grease  
**Controls:** 3s + B remote  
**Finish:** White Cristalplant  
**Lighting:** Strip LED 7 W 4000k  
**Version:** Duct out/Recycling

TOP  
PERFORMANCEHIGH  
PERFORMANCEREVOLUTION  
FILTERREVOLUTION  
FILTER

A Duct out version

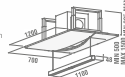
MAX 1200MM  
MIN 300-400x 300

F Recycling version

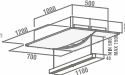
MAX 1200MM  
MIN 300-400x 300

HOME

REVOLUTION  
FILTERHIGH  
PERFORMANCE

≥ 50 cm



≥ 60 cm

SENSOR  
TECHNOLOGY

DIM LIGHT





## CLOUD NINE

Size: 120 x 65 cm  
 Max airflow: 669 m<sup>3</sup>/h  
 Filter: Grease  
 Controls: 3s + B remote  
 Finish: SS + White Glass  
 Lighting: Neon 21w

Aluminium grease filter and Charcoal filter included

Kit remote control included.

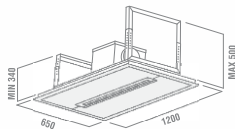

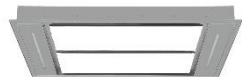

## GLACIER T10 WH

|              |                        |
|--------------|------------------------|
| Size:        | 110 cm                 |
| Max airflow: | 1100 m3/h              |
| Filter:      | Cassette               |
| Controls:    | Electronic (Remote)    |
| Finish:      | SS + White/Black Glass |
| Lighting:    | LED 2W x 4 =8          |

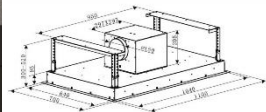

# INTERSTELLAR

A RED CARPET  
OBJECT THAT  
ALWAYS CREATES  
THE PERFECT  
ATMOSPHERE.

Absolute star of the space, this chandelier hood creates a magical atmosphere, with prisms in glass that reflect plays of light and color. A refined and balanced product thanks to the combination of materials and LED lights. During the day, it reflects natural light, at night it lights up with special effects. Interstellar is a hood made for the red carpet.





## INTERESTELLAR

|              |                                |
|--------------|--------------------------------|
| Size:        | Ø 65 cm                        |
| Max airflow: | 400 m <sup>3</sup> /h          |
| Filter:      | Grease                         |
| Controls:    | 3s + B remote                  |
| Finish:      | Glass,                         |
| Lighting:    | Strip LED 9W + LED 2x20W 3500k |

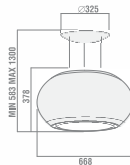

Grease Polyurethane filter and Revolution Filter included

ACCESSORIES : Long life filter, Extension cable kit (5m IX)



EASY  
INSTALLATION

DIM LIGHT

AMBIENT  
LIGHT

REVOLUTION  
FILTER

SENSOR  
TECHNOLOGY

≥ 65 cm

≥ 50 cm



FINISHES WITH  
CHARACTER, LIGHT BODY,  
TECHNOLOGICAL SOUL.



SHINING  
RUST

Models with great character that become gentle through dim lighting. Lines are simple and natural, while their technological heart is dressed in innovative finishes.

Like all the models in the Técnica line, also shining is environmentally-friendly. It immediately recognizes the air quality and adjusts itself accordingly.





SHINING CAST IRON



SHINING RUST



SHINING COPPER



SHINING PELTOX



## SHINING

- Size: Ø 50 cm  
 Max airflow: 400 m<sup>3</sup>/h  
 Filter: Grease  
 Controls: 3s + B remote  
 Finish: Peltox, Metal, Rust, Copper, Cast Iron  
 Lighting: LED 9W 3500K



HOME

A+

≥ 50 cm

≥ 65 cm

SENSOR  
TECHNOLOGYEASY  
INSTALLATIONREVOLUTION  
FILTER



## FEEL

|              |                       |
|--------------|-----------------------|
| Size:        | 80 cm                 |
| Max airflow: | 801 m <sup>3</sup> /h |
| Filter:      | Grease                |
| Controls:    | E-motion              |
| Finish:      | Glass Colours         |
| Lighting:    | Strip LED 7W 4000k    |

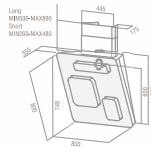

With e-motion, the natural and intuitive control system. Simply touch the electronically activated panels to operate them.



HOME



≥ 30 cm



≥ 30 cm

TOP  
PERFORMANCELONG LIFE  
FILTERBACK  
ASPIRATIONEASY  
INSTALLATIONA+  
Energy class

SWEET  
COPPER

A CLASSIC ATTITUDE  
TO MODERNITY.



Sweet's ability to harmonize with the contemporary living space is confirmed. The technopolymer allows for feathery lines that make shapes softer. A thin polished stainless steel line characterizes the elegant perimeter aspiration system, which increases cooking fumes uptake speed.





INDUSTRIAL CHARM  
FROM BYGONE DAYS.



The hood descends, widens, and curves defining a wall as if it were a sculpture. It is not a post-modern art piece but a kitchen hood. The design aimed it to render it unique looking and to fascinate us with that industrial feeling from another time.



## SWEET

Size: 85 cm  
 Filter: Grease  
 Max airflow: 800 m<sup>3</sup>/h  
 Controls: 3s + B Touch  
 Finish: Copper, Peltrox, Cast Iron  
 Lighting: Strip LED 7W 4000K

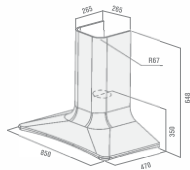

≥ 60 cm



≥ 70 cm



HIGH  
PERFORMANCE



LONG LIFE  
FILTER



B  
ENERGY CLASS



## SPACE

Size:  $\varnothing$  78 cm  
 Max Air Flow: 750 m<sup>3</sup>/h  
 Filter: Grease EDS3  
 Controls: 3s + Digital  
 Finish: Black/White Glass  
 Lighting: Halo 2x20 W

30%  
NOISE  
REDUCTION

21dB  
QUIETER

25%  
NOISE  
SUCTION



$\geq$  50 cm



$\geq$  65 cm



DEEP  
SILENCE



LONG LIFE  
FILTER



HIGH  
PERFORMANCE

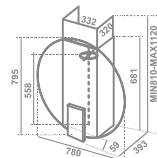



## CHROME ISLAND

Size : 85 x 43 cm  
 Max Air Flow : 750 m3/h  
 Filter : Grease EDS3  
 Controls : Magic Wand  
 Lighting : Halo 2 x 20 W - 4 x 20 W  
 Finish : Shiny Stainless Steel

30%  
NOISE  
REDUCTION

21dB  
QUIETER

25%  
NOISE  
SUCTION



≥ 50 cm



≥ 65 cm



DEEP  
SILENCE



LONG LIFE  
FILTER



HIGH  
PERFORMANCE

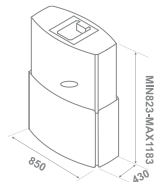



## CIRCLE ISLAND 350 NERO

|              |                        |
|--------------|------------------------|
| Size:        | Ø 35 cm                |
| Max airflow: | 1000 m <sup>3</sup> /h |
| Filter:      | Cassette               |
| Controls:    | Soft Touch Electronic  |
| Finish:      | Black                  |
| Lighting:    | LED 2 x 1 W            |

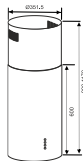

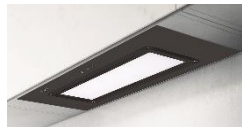

## HOOD-UC 75

|              |                                   |
|--------------|-----------------------------------|
| Size:        | 75 cm                             |
| Max airflow: | 1100 m <sup>3</sup> /h            |
| Filter:      | Cassette                          |
| Controls:    | Touch Control with<br>LED Display |
| Finish:      | White/Black                       |
| Lighting:    | LED Panel 22 W                    |

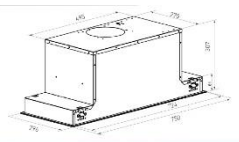



## METEORITE UC35 EDS PLUS

- Size:** 60/90 cm  
**Max Air Flow:** T-1220 m3/h  
**Filter:** 3D Filter  
**Controls:** Touch  
**Finish:** Black+ Black with Gray  
**Lighting:** LED Strip  
**Technology:** EDS

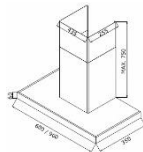



i-SMART  
KITCHENHOODS





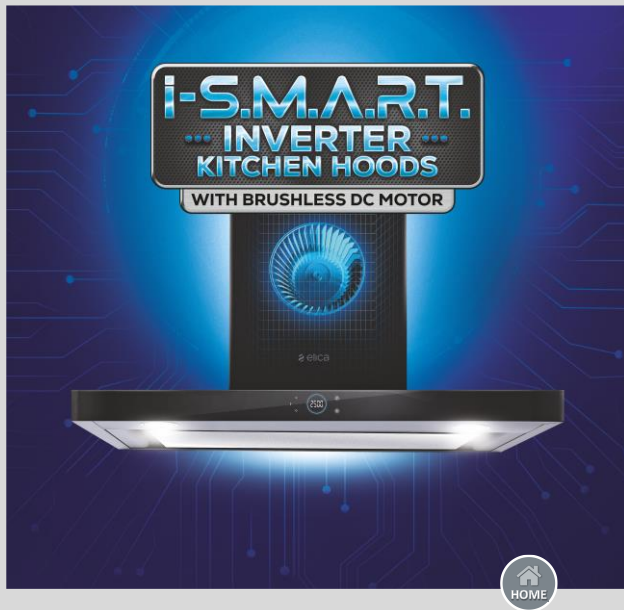

Introducing Future Ready Chimneys  
 - The Elica **i-S.M.A.R.T.** Range  
 with Inverter + Silent Motor Auto RPM Technology  
 which delivers **5 Star Performance**  
 for everything you need today and tomorrow.

**POWER SAVINGS**

UPTO  
80%



**POWERFUL SUCTION**

EVEN WITH  
30 FT  
DUCTING



**INTELLI SPEED**

AUTO ADJUSTS  
UPTO 2500 R.P.M.  
FOR CONSISTENT  
SUCTION



**SUPER QUIET**

DEEP  
SILENCE 2.0  
TECHNOLOGY



**FLEXI VOLTAGE OPERATION**

40V TO 280V  
INCLUDING  
HOME INVERTER



MOTION  
SENSOR



24  
SPEED  
WITH RPM  
DISPLAY



LIFETIME  
WARRANTY



MADE  
IN INDIA

## i-SMART SUPER QUIET DEEP SILENCE 2.0



**i-S.M.A.R.T.**  
 ... INVERTER ...  
 KITCHEN HOODS  
 WITH BRUSHLESS DC MOTOR

I SMART SPOT H6 EDS  
LTW NERO

|                   |  |
|-------------------|--|
| Size:             | 60/90 cm                                       |
| Filter:           | 3D Filter                                      |
| Controls:         | Capacitive Touch Control<br>with Motion Sensor |
| Speed :           | 24 with RPM Display                            |
| Motor RPM (Max) : | 2500   |
| Input Power :     | 10 w   |
| Finish:           | Black  |
| Lighting:         | LED Lamps                                      |
| Warranty :        | Lifetime                                       |
| Technology :      | Inverter with Deep Silence 2.0                 |

Also available in Island

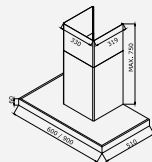

## i-SMART SUPER QUIET DEEP SILENCE 2.0



**i-S.M.A.R.T.**  
 ... INVERTER ...  
 KITCHEN HOODS  
 WITH BRUSHLESS DC MOTOR

I SMART GALAXY EDS  
LTW NERO

|                   |  |
|-------------------|--|
| Size:             | 60/90 cm                                       |
| Filter:           | 3D Filter                                      |
| Controls:         | Capacitive Touch Control<br>with Motion Sensor |
| Speed :           | 25 with RPM Display                            |
| Motor RPM (Max) : | 2500   |
| Input Power :     | 10 w   |
| Finish:           | Black  |
| Lighting:         | LED Lamps                                      |
| Warranty :        | Lifetime                                       |
| Technology :      | Inverter with Deep Silence 2.0                 |

Also available in Island

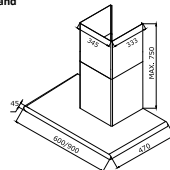

## i-SMART SUPER QUIET DEEP SILENCE 2.0



### I SMART GLACE EDS LTW NERO

|                   |  |
|-------------------|--|
| Size:             | 60/90 cm                                       |
| Filter:           | 3D Filter                                      |
| Controls:         | Capacitive Touch Control<br>with Motion Sensor |
| Speed :           | 24 with RPM Display                            |
| Motor RPM (Max) : | 2500   |
| Input Power :     | 10 w   |
| Finish:           | Black  |
| Lighting:         | LED Lamps                                      |
| Warranty :        | Lifetime                                       |
| Technology :      | Inverter with Deep Silence 2.0                 |

Also available in Island

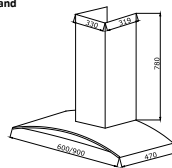

## i-SMART SUPER QUIET DEEP SILENCE 2.0



### I SMART SPOT H4 EDS LTW NERO

|                   |  |
|-------------------|--|
| Size:             | 60/90 cm                                       |
| Filter:           | 3D Filter                                      |
| Controls:         | Capacitive Touch Control<br>with Motion Sensor |
| Speed :           | 25 with RPM Display                            |
| Motor RPM (Max) : | 2500   |
| Input Power :     | 10 w   |
| Finish:           | Black  |
| Lighting:         | LED Lamps                                      |
| Warranty :        | Lifetime                                       |
| Technology :      | Inverter with Deep Silence 2.0                 |

Also available in Island

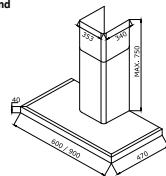

## i-SMART BAFFLE FILTER

I SMART SPOT H6 BF  
LTW NERO

|                   |  |
|-------------------|--|
| Size:             | 60/90 cm                                       |
| Filter:           | Baffle Filter                                  |
| Controls:         | Capacitive Touch Control<br>with Motion Sensor |
| Speed :           | 24 with RPM Display                            |
| Motor RPM (Max) : | 2500   |
| Input Power :     | 10 w   |
| Finish:           | Black  |
| Lighting:         | LED Lamps                                      |
| Technology :      | Inverter                                       |
| Warranty :        | Lifetime                                       |

Also available in Island

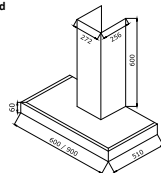

## i-SMART BAFFLE FILTER



### I SMART GALAXY BF LTW NERO

|                   |  |
|-------------------|--|
| Size:             | 60/90 cm                                       |
| Filter:           | Baffle Filter                                  |
| Controls:         | Capacitive Touch Control<br>with Motion Sensor |
| Speed :           | 25 with RPM Display                            |
| Motor RPM (Max) : | 2500   |
| Input Power :     | 10 w   |
| Finish:           | Black  |
| Lighting:         | LED Lamps                                      |
| Technology :      | Inverter                                       |
| Warranty :        | Lifetime                                       |

Also available in Island

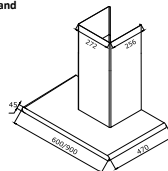

## i-SMART BAFFLE FILTER



### I SMART GLACE TRIM BF 60 LTW NERO

|                   |  |
|-------------------|--|
| Size:             | 60 cm  |
| Filter:           | Baffle Filter                                  |
| Controls:         | Capacitive Touch Control<br>with Motion Sensor |
| Speed :           | 25 with RPM Display                            |
| Motor RPM (Max) : | 2500   |
| Input Power :     | 10 w   |
| Finish:           | Black  |
| Lighting:         | LED Lamps                                      |
| Technology :      | Inverter                                       |
| Warranty :        | Lifetime                                       |

Also available in Island

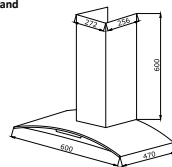



## i-SMART BAFFLE FILTER

I SMART GLACE TRIM  
BF 903 LTW NERO

|                   |  |
|-------------------|--|
| Size:             | 90 cm  |
| Filter:           | 3 Baffle Filters                               |
| Controls:         | Capacitive Touch Control<br>with Motion Sensor |
| Speed :           | 25 with RPM Display                            |
| Motor RPM (Max) : | 2500   |
| Input Power :     | 10 w   |
| Finish:           | Black  |
| Lighting:         | LED Lamps                                      |
| Technology :      | Inverter                                       |
| Warranty :        | Lifetime                                       |

Also available in Island

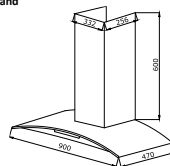

## i-SMART BAFFLE FILTER WITH HEAT AUTO-CLEAN



### I SMART GLACE HAC BF LTW NERO

#### HEAT AUTO-CLEAN KITCHENHOOD

|                   |  |
|-------------------|--|
| Size:             | 60/75/90 cm                                    |
| Filter:           | Baffle Filter                                  |
| Controls:         | Capacitive Touch Control<br>with Motion Sensor |
| Speed :           | 24 with RPM Display                            |
| Motor RPM (Max) : | 2500   |
| Input Power :     | 10 w   |
| Finish:           | Black  |
| Lighting:         | LED Lamps                                      |
| Technology :      | Inverter                                       |
| Warranty :        | Lifetime                                       |

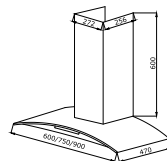

## i-SMART BAFFLE &amp; CASSETTE FILTER



**i-S.M.A.R.T.**  
 ... INVERTER ...  
 KITCHEN HOODS  
 WITH BRUSHLESS DC MOTOR



## SMART KITTY LTW NERO

|                   |  |
|-------------------|--|
| Size:             | 60/75 cm                                       |
| Filter:           | Cassette & Baffle Filter                       |
| Controls:         | Capacitive Touch Control<br>with Motion Sensor |
| Speed :           | 24 with RPM Display                            |
| Motor RPM (Max) : | 2500   |
| Input Power :     | 10 w   |
| Finish:           | Black  |
| Lighting:         | LED Lamps                                      |
| Technology:       | Inverter                                       |
| Warranty :        | Lifetime                                       |

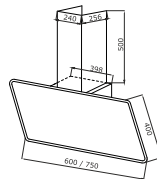

# i-SMART FILTERLESS HEAT AUTO CLEAN



**i-S.M.A.R.T.**  
 ... INVERTER ...  
**KITCHEN HOODS**  
 WITH BRUSHLESS DC MOTOR



## I SMART EFL HAC LTW

|                   |  |
|-------------------|--|
| Size:             | 90cm   |
| Filter:           | 3D Filter                                      |
| Controls:         | Capacitive Touch Control<br>with Motion Sensor |
| Speed :           | 24 with RPM Display                            |
| Motor RPM (Max) : | 2000   |
| Input Power :     | 100 w  |
| Finish:           | Black  |
| Lighting:         | LED Lamps                                      |
| Technology:       | Inverter                                       |
| Warranty :        | Lifetime                                       |

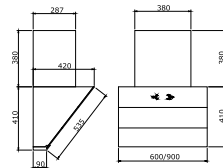

SILENT CHIMNEY DESIGNED FOR YOUR EARS





## METORITE EDS HE TOUCH

|                   |                               |
|-------------------|-------------------------------|
| Size (cm) :       | 90/120                        |
| Air Flow (m3/h) : | T-1010 & T-1220               |
| Filter :          | 3D Filter                     |
| Controls :        | Touch 4 Speed                 |
| Lighting :        | LED Strip 7W 2700-6000K       |
| Air Outlet Size : | 150 mm                        |
| Finish :          | Stainless Steel + Black Glass |
| Warranty :        | Lifetime                      |
| Technology :      | Eds3                          |

30%  
NOISE  
REDUCTION

21dB  
 quieter

25%  
MORE  
SUCKTION

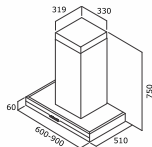



≥ 58 cm



≥ 63 cm



TOP PERFORMANCE



REVOLUTION IN DESIGN



TOUCH WALL



EASY INSTALLATION



## METEORITE EDS HE TOUCH WALL

- Size (cm) : 60/90
- Air Flow (m3/h) : T-1010 & T-1220
- Filter : 3D Filter
- Controls : Touch 4 Speed
- Lighting : LED Strip 7W
- Air Outlet Size : 150 mm
- Finish : Stainless Steel + Black Glass
- Warranty : Lifetime
- Technology : Eds3

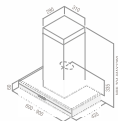

30% MORE EFFICIENT

21dB QUIETER

25% MORE EFFICIENT



## EDS DEEP SILENCE KITCHENHOOD

KITTY SLIM EDS HE  
LTW T4V LED

|               |             |
|---------------|-------------|
| Size:         | 60 / 90 cm  |
| Filter:       | 3D Filter   |
| Max Air Flow: | T-1010 m3/h |
| Controls:     | Touch T4V   |
| Finish:       | Black Glass |
| Lighting:     | LED 2 X 2W  |
| Technology:   | EDS3        |

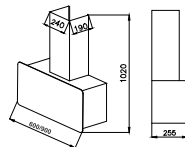
DEEP  
SILENCEHIGH  
PERFORMANCE30%  
NOISE  
REDUCTION21dB  
QUIETER25%  
NOISE  
SUCTION



## EDS DEEP SILENCE KITCHENHOOD

METEORITE EDS HE  
LTW T4V LED

|               |                          |
|---------------|--------------------------|
| Size:         | 60 / 90 cm               |
| Filter:       | 3D Filter                |
| Max Air Flow: | T-1010 m <sup>3</sup> /h |
| Controls:     | Touch T4V                |
| Finish:       | Black                    |
| Lighting:     | LED                      |
| Technology:   | EDS3                     |

Also available in Island

30%  
NOISE  
REDUCTION

21dB  
QUIETER

25%  
MORE  
SUCTION



DEEP  
SILENCE



HIGH  
PERFORMANCE

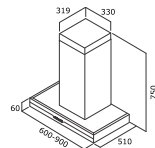

## EDS DEEP SILENCE KITCHENHOOD

GALAXY EDS HE LTW  
T4V LED

|               |             |
|---------------|-------------|
| Size:         | 60 / 90 cm  |
| Filter:       | 3D Filter   |
| Max Air Flow: | T-1010 m3/h |
| Controls:     | Touch T4V   |
| Finish:       | Black       |
| Lighting:     | LED         |
| Technology:   | EDS3        |

Also available in Island

30%  
NOISE  
REDUCTION

21dB  
QUIETER

25%  
MORE  
SUCTION



DEEP  
SILENCE



HIGH  
PERFORMANCE

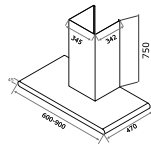

## EDS DEEP SILENCE KITCHENHOOD

SPOT H4 EDS HE LTW  
NERO T4V LED

|               |             |
|---------------|-------------|
| Size:         | 60 / 90 cm  |
| Filter:       | 3D Filter   |
| Max Air Flow: | T-1010 m3/h |
| Controls:     | Touch T4V   |
| Finish:       | Black       |
| Lighting:     | LED         |
| Technology:   | EDS3        |

Also available in Island

30%  
NOISE  
REDUCTION

21dB  
QUIETER

25%  
MORE  
SUCTION



DEEP  
SILENCE



HIGH  
PERFORMANCE

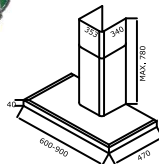

## EDS DEEP SILENCE KITCHENHOOD

SPOT H4 TRIM EDS HE  
LTW NERO T4V LED

|               |             |
|---------------|-------------|
| Size:         | 60 / 90 cm  |
| Filter:       | 3D Filter   |
| Max Air Flow: | T-1010 m3/h |
| Controls:     | Touch T4V   |
| Finish:       | Black       |
| Lighting:     | LED         |
| Technology:   | EDS3        |

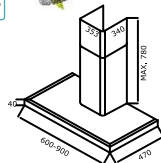
DEEP  
SILENCEHIGH  
PERFORMANCE30%  
NOISE  
REDUCTION21dB  
QUIETER25%  
NOISE  
SUCTION

## EDS DEEP SILENCE KITCHENHOOD

GLACE EDS HE LTW  
BK NERO T4V LED

|               |   |
|---------------|---|
| Size:         | 60 / 75 / 90 cm                             |
| Finish :      | Black                                       |
| Lighting:     | 60 cm & 75cm- LED Lamp,<br>90cm - LED Strip |
| Filter:       | 3D Filter                                   |
| Max Air Flow: | T-1010 m3/h                                 |
| Controls:     | Touch T4V                                   |

Also available in Island

30%  
NOISE  
REDUCTION

21dB  
MAX/1M

25%  
MORE  
SUCKTION



DEEP  
SILENCE



HIGH  
PERFORMANCE





# VERTICAL KITCHENHOODS



## VERTICAL KITCHENHOOD



### OM ETB HE/ MINI OM ETB HE

|                    |                     |
|--------------------|---------------------|
| Size (cm) :        | 60/80               |
| Air Flow (m3/hr) : | 1220                |
| Filter :           | Cassette            |
| Controls :         | Touch               |
| Lighting :         | LED 2 X 1.5 W       |
| Air Outlet Size :  | 150 mm              |
| Finish :           | Black / White Glass |
| Warranty :         | Lifetime            |



≥ 35 cm



LONG LIFE  
FILTER



HIGH  
PERFORMANCE



EASY  
INSTALLATION

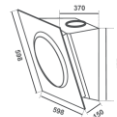

MINI OM ETB HE

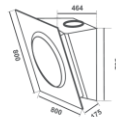

OM ETB HE

## VERTICAL KITCHENHOOD



### KITTY ETB

|                    |                     |
|--------------------|---------------------|
| Size (cm) :        | 60/80               |
| Air Flow (m3/hr) : | 1220                |
| Filter :           | Baffle + Cassette   |
| Controls :         | Touch T4V           |
| Lighting :         | LED 2 x 1.5 W       |
| Air Outlet Size :  | 150 mm              |
| Finish :           | Black + Black Glass |
| Warranty :         | Lifetime            |



≥ 45 cm



HIGH PERFORMANCE

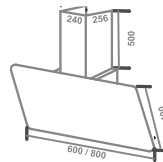



## VERTICAL KITCHENHOOD

GRACEFUL PLUS  
ETB HE

|                    |                   |
|--------------------|-------------------|
| Size (cm) :        | 60/90             |
| Air Flow (m3/hr) : | 1220              |
| Filter :           | Baffle + Cassette |
| Controls :         | Touch T4V         |
| Lighting :         | LED 1 X 1.5 W     |
| Air Outlet Size :  | 150 mm            |
| Finish :           | Black Glass       |
| Warranty :         | Lifetime          |

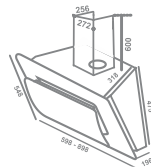

≥ 45 cm

HIGH  
PERFORMANCEEASY  
INSTALLATION

## SLIM VERTICAL HOOD WITH BLDC MOTOR

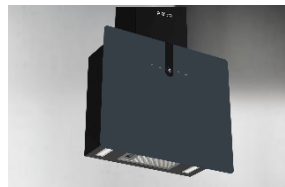

## SLIM BLDC 60 NERO

|               |                        |
|---------------|------------------------|
| Size :        | 60 cm                  |
| Max Air Flow: | 1150 m <sup>3</sup> /h |
| Filter :      | AI Cassette (3 nos.)   |
| Control:      | <b>9 Speed Touch</b>   |
| Motor:        | <b>Brushless DC</b>    |
| Finish:       | Black                  |
| Lighting:     | LED 2 x 2 W            |

## Easy to Clean



≥ 45CM

EASY  
INSTALLATION

LED LAMP

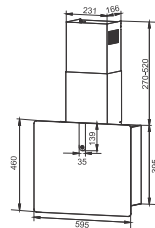

FILTERLESS  
& HAC  
KITCHENHOODS



## FILTER LESS

Elica Filter less Kitchenhoods are fitted with sealed motor to ensure that oil deposit and water vapours does not affect the smooth functioning of the motor. High quality metal blower system ensure that the smoke and odour are efficiently exhausted out of the kitchen.

## MOTION CONTROL

Select Kitchenhood model in Heat Auto Clean & Filter less type are fitted with Motion Control that enables easy operation by a simple wave of your hand. Wave your hand towards right to turn on the chimney and continue waving to increase the speed. While waving towards left will decrease the speed and finally turns it off.

## HEAT AUTOCLEAN

Kitchenhood is fitted with Heating pad on it's motor group assembly and oil collector cup at the bottom. Just with a touch on control panel, kitchenhood can be cleaned by collecting oil from Motor group assembly in to the oil collector cup with the help of Heating Pad.



# FILTERLESS + HEAT AUTO CLEAN VERTICAL KITCHENHOOD



## EFL 107 HAC LTW VMS 60

- Size : 60 cm  
 Max Air Flow: 1350 m3/h  
 Control: **3 Speed with Palm Sensor**  
 Finish: Black  
 Lighting: LED 1 X 1.5W  
 Black Oil Collector  
 Easy to Clean  
**Heat Auto Clean**



PALM SENSOR



≥ 45CM



EASY  
INSTALLATION



LED LAMP

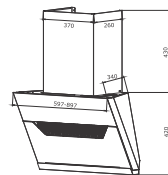

# FILTERLESS + HEAT AUTO CLEAN VERTICAL KITCHENHOOD



## EFL 107 HAC LTW VMS 90

- Size : 90 cm  
 Max Air Flow: 1350 m<sup>3</sup>/h  
 Control: **3 Speed with Palm Sensor**  
 Finish: Black  
 Lighting: LED 1 X 1.5W  
 Black Oil Collector  
 Easy to Clean  
**Heat Auto Clean**



PALM SENSOR



≥ 45CM



EASY  
INSTALLATION



LED LAMP

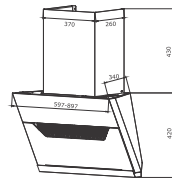

# FILTERLESS + HEAT AUTO CLEAN VERTICAL KITCHENHOOD



## EFL 108 HAC LTW VMS 60

- Size : 60 cm  
 Max Air Flow: 1350 m<sup>3</sup>/h  
 Control: **3 Speed with Palm Sensor**  
 Finish: Black  
 Lighting: LED 1 X 1.5W  
 Black Oil Collector  
 Easy to Clean  
**Heat Auto Clean**



PALM SENSOR



≥ 45CM



EASY  
INSTALLATION



LED LAMP

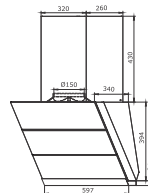

# FILTERLESS + HEAT AUTO CLEAN VERTICAL KITCHENHOOD



## EFL 108 HAC LTW VMS 90

- Size : 90 cm  
 Max Air Flow: 1350 m<sup>3</sup>/h  
 Control: **3 Speed with Palm Sensor**  
 Finish: Black  
 Lighting: LED 1 X 1.5W  
 Black Oil Collector  
 Easy to Clean  
**Heat Auto Clean**



PALM SENSOR



≥ 45CM



EASY  
INSTALLATION



LED LAMP

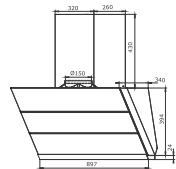



# FILTERLESS + HEAT AUTO CLEAN VERTICAL KITCHENHOOD



## EFL-S 60I HAC LTW VMS

Size : 60 cm  
 Max Air Flow: 1200 m<sup>3</sup>/h  
 Control: 3 Speed Motion  
 Finish: Black  
 Lighting: LED 1 X 1.5W  
 Oil Collector, Easy to Clean

### Heat Auto Clean

Also available in 90/75 cm

Also available in 1310 m<sup>3</sup>/h Max Air Flow



MOTION  
CONTROL



≥ 45 CM



EASY  
INSTALLATION



LED LAMP

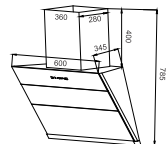

# FILTERLESS + HEAT AUTO CLEAN VERTICAL KITCHENHOOD



## EFL-S 601 ULTRA HAC VMS

Size : 60/75/90 cm  
 Max Air Flow: 1500 m3/h  
 Control: 3 Speed Motion  
 Finish: Black  
 Lighting: LED 1 X 1.5W  
 Oil Collector, Easy to Clean

### Heat Auto Clean



MOTION  
CONTROL



≥ 45 CM



EASY  
INSTALLATION



LED LAMP

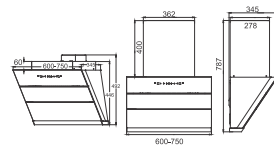

# FILTERLESS + HEAT AUTO CLEAN VERTICAL KITCHENHOOD

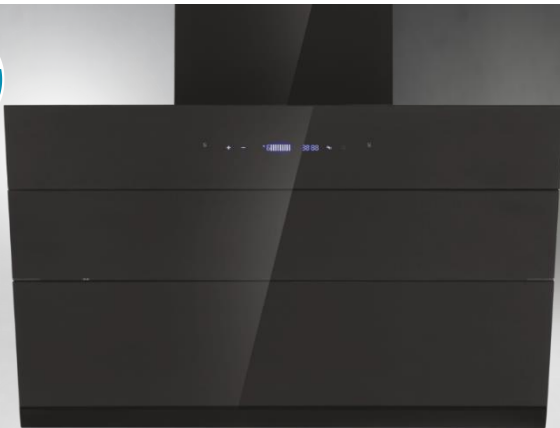

## EFL-S 6TI BLDC HAC LTW VMS



|                              |  |
|------------------------------|--|
| Size :                       | 60/75/90 cm                            |
| Max Air Flow:                | 1400 m <sup>3</sup> /h                 |
| Control:                     | <b>9 Speed Motion with RPM Display</b> |
| Motor:                       | <b>Brushless DC</b>                    |
| Finish:                      | <b>Black</b>                           |
| Lighting:                    | <b>LED 1 X 1.5W</b>                    |
| Oil Collector, Easy to Clean |  |

### Heat Auto Clean



MOTION  
CONTROL



≥ 45 CM



EASY  
INSTALLATION



LED LAMP

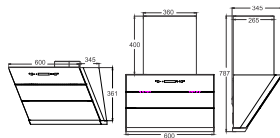

# FILTERLESS + HEAT AUTO CLEAN VERTICAL KITCHENHOOD



## EFL-S 607 HAC VMS

|               |                |
|---------------|----------------|
| Size :        | 60/90 cm       |
| Max Air Flow: | 1100 m3/h      |
| Control:      | 3 Speed Motion |
| Finish:       | Black          |
| Lighting:     | Long LED Lamp  |

### Heat Auto Clean

Oil Collector, Easy to Clean

Also available without Heat Auto Clean

Also available in 90 cm with HAC



MOTION  
CONTROL



≥ 45 CM



EASY  
INSTALLATION



LED LAMP

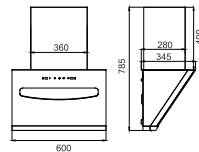

# FILTERLESS + HEAT AUTO CLEAN VERTICAL KITCHENHOOD



## EFL-S 607 BLDC HAC LTW VMS

|                              |  |
|------------------------------|--|
| Size :                       | 60 cm                                  |
| Max Air Flow:                | 1400 m <sup>3</sup> /h                 |
| Control:                     | <b>9 Speed Motion with RPM Display</b> |
| Motor:                       | <b>Brushless DC</b>                    |
| Finish:                      | Black                                  |
| Lighting:                    | LED 1 X 1.5W                           |
| Oil Collector, Easy to Clean |  |

### Heat Auto Clean



MOTION  
CONTROL



≥ 45 CM



EASY  
INSTALLATION



LED LAMP

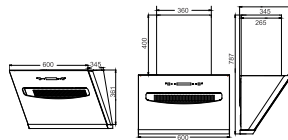

# FILTERLESS + HEAT AUTO CLEAN VERTICAL KITCHENHOOD



## EFL-S 907 BLDC HAC LTW VMS

|                              |  |
|------------------------------|--|
| Size :                       | 90 cm                                  |
| Max Air Flow:                | 1400 m3/h                              |
| Control:                     | <b>9 Speed Motion with RPM Display</b> |
| Motor:                       | <b>Brushless DC</b>                    |
| Finish:                      | Black                                  |
| Lighting:                    | LED 1 X 1.5W                           |
| Oil Collector, Easy to Clean |  |

### Heat Auto Clean



MOTION  
CONTROL



≥ 45 CM



EASY  
INSTALLATION



LED LAMP

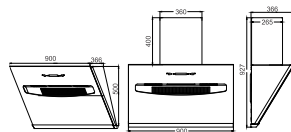

# FILTERLESS VERTICAL KITCHENHOOD



## EFL GRACEFUL PLUS LTW

|               |               |
|---------------|---------------|
| Size :        | 60/90 cm      |
| Max Air Flow: | 1425 m3/h     |
| Control:      | Touch TC3V    |
| Finish:       | Black         |
| Lighting:     | Long LED Lamp |

### Concealed Motor

Oil Collector, Easy to Clean



≥ 45 CM



EASY  
INSTALLATION



LED LAMP

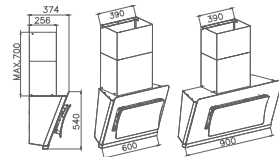

## FILTERLESS + HEAT AUTO CLEAN KITCHENHOOD



### EFL-S 903 V 8PS PLUS

Size : 90 cm  
 Finish : Black glass  
 Control : 8 Speed sliding Touch Control  
 Max Air Flow: 1150 (m3/h)  
 Long LED lamp (1 X 3W)

- Frequency changing brushless motor automatically changes its RPM corresponding to the change in suction pressure.
- Motor RPM display 60 seconds delay SHUT OFF function,
- Unique Air Exchange shut off function
- Wider suction chamber entrance Larger SS oil collector cup
- Duct cover with black glass front
- Hassle free maintenance



≥ 45 CM



EASY  
INSTALLATION



LED LAMP

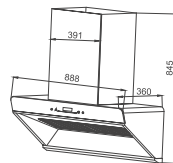



## FILTERLESS + HEAT AUTO CLEAN KITCHENHOOD



### WDFL 606 HAC MS NERO

Size: 60 cm  
 Max Air Flow: 1200 m3/h  
 Control: 3 Speed Motion  
 Finish: Black  
 Lighting: LED 2 X 1.5W  
 SS Oil Collector, Easy to Clean

**Heat Auto Clean**  
**Concealed Motor**



MOTION  
CONTROL



≥ 65 CM



EASY  
INSTALLATION



LED LAMP

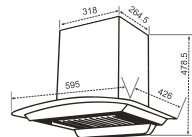

## FILTERLESS + HEAT AUTO CLEAN KITCHENHOOD



### WDFL 906 HAC MS NERO

Size: 60 cm  
 Max Air Flow: 1200 m3/h  
 Control: 3 Speed Motion  
 Finish: Black  
 Lighting: LED 2 X 1.5W  
 SS Oil Collector, Easy to Clean

**Heat Auto Clean**  
**Concealed Motor**



MOTION  
CONTROL



≥ 65 CM



EASY  
INSTALLATION



LED LAMP

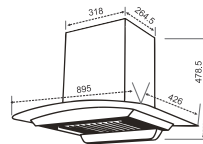

# FILTERLESS + HEAT AUTO CLEAN KITCHENHOOD



## FLCG 600/900 HAC LTW MS NERO

Size: 60/90 cm  
 Max Air Flow: 1350 m<sup>3</sup>/h  
 Control: 3 Speed Motion  
 Finish: Black  
 Lighting: LED 2 x 1.5W  
 Oil Collector, Easy to Clean  
**Lifetime Warranty on Motor**  
**Heat Auto Clean**



MOTION  
CONTROL



≥ 65 CM



EASY  
INSTALLATION



LED LAMP

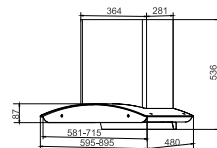

# FILTERLESS + HEAT AUTO CLEAN KITCHENHOOD



## FLCG PLUS LTW 600/900 HAC MS NERO

Size: 60/90 cm  
 Max Air Flow: 1500 m<sup>3</sup>/h  
 Control: 3 Speed Motion  
 Finish: Black  
 Lighting: LED 2 x 1.5W  
 Oil Collector, Easy to Clean  
**Lifetime Warranty on Motor**  
**Heat Auto Clean**



MOTION  
CONTROL



≥ 65 CM



EASY  
INSTALLATION



LED LAMP

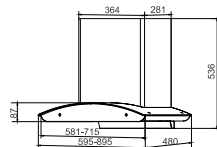

# FILTERLESS + HEAT AUTO CLEAN KITCHENHOOD



## WD TFL HAC MS NERO

|               |                        |
|---------------|------------------------|
| Size:         | 60/90 cm               |
| Max Air Flow: | 1425 m <sup>3</sup> /h |
| Control:      | 3 Speed Motion         |
| Finish:       | Black                  |
| Lighting:     | LED 2 X 2W             |

**Heat Auto Clean**  
Oil Collector, Easy to Clean



MOTION  
CONTROL



≥ 65 CM



EASY  
INSTALLATION



LED LAMP

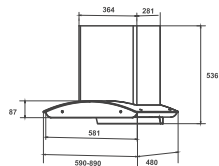

# FILTERLESS + HEAT AUTO CLEAN KITCHENHOOD



## FLCG PB 600/900 HAC NERO

|               |             |
|---------------|-------------|
| Size:         | 60/90 cm    |
| Max Air Flow: | 1200 m3/h   |
| Control:      | Push Button |
| Finish:       | Black       |
| Lighting:     | LED 1 x 2W  |
| Oil Collector |             |
| Easy to Clean |             |



≥ 65 CM



EASY  
INSTALLATION



LED LAMP

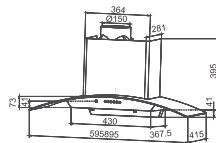

# BAFFLE FILTER WITH HEAT AUTO CLEAN KITCHENHOOD



## BFCG 600 HAC LTW MS NERO

|               |                |
|---------------|----------------|
| Size:         | 60 cm          |
| Filter :      | Baffle         |
| Max Air Flow: | 1350 m3/h      |
| Control:      | 3 Speed Motion |
| Finish:       | Black          |
| Lighting:     | LED 2 X 1.5W   |

Oil Collector, Easy to Clean

**Heat Auto Clean**

**Lifetime Warranty on Motor**



MOTION CONTROL



≥ 65 CM



EASY INSTALLATION



LED LAMP

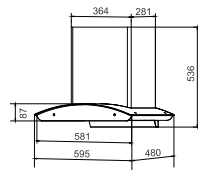

# BAFFLE FILTER WITH HEAT AUTO CLEAN KITCHENHOOD



## BFCG 900 HAC LTW MS NERO

Size: 90 cm  
 Filter : Baffle  
 Max Air Flow: 1350 m3/h  
 Control: 3 Speed Motion  
 Finish: Black  
 Lighting: LED 2 X 1.5W

Oil Collector, Easy to Clean

**Heat Auto Clean**

**Lifetime Warranty on Motor**



MOTION  
CONTROL



≥ 65 CM



EASY  
INSTALLATION



LED LAMP

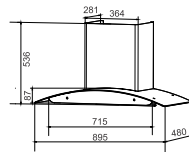



# BAFFLE FILTER WITH HEAT AUTO CLEAN KITCHENHOOD



## BFCG PLUS LTW 600 HAC MS NERO

Size: 60 cm  
 Filter : Baffle  
 Max Air Flow: 1500 m3/h  
 Control: 3 Speed Motion  
 Finish: Black  
 Lighting: LED 2 X 1.5W

Oil Collector, Easy to Clean

**Heat Auto Clean**

**Lifetime Warranty on Motor**



MOTION  
CONTROL



≥ 65 CM



EASY  
INSTALLATION



LED LAMP

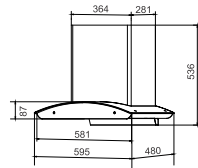

## BAFFLE FILTER WITH HEAT AUTO CLEAN KITCHENHOOD



### BFCG PLUS LTW 900 HAC MS NERO

Size: 90 cm  
 Filter : Baffle  
 Max Air Flow: 1500 m3/h  
 Control: 3 Speed Motion  
 Finish: Black  
 Lighting: LED 2 X 1.5W

Oil Collector, Easy to Clean

**Heat Auto Clean**

**Lifetime Warranty on Motor**



MOTION  
CONTROL



≥ 65 CM



EASY  
INSTALLATION



LED LAMP

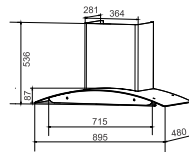

## BAFFLE FILTER WITH HEAT AUTO CLEAN KITCHENHOOD



### WD TBF HAC 60 MS NERO

|                              |                |
|------------------------------|----------------|
| Size :                       | 60 cm          |
| Filter:                      | Baffle         |
| Max Air Flow:                | 1425 m3/h      |
| Control:                     | 3 Speed Motion |
| Finish:                      | Black          |
| Lighting:                    | LED 2 X 2W     |
| Oil Collector, Easy to Clean |                |
| <b>Heat Auto Clean</b>       |                |



MOTION  
CONTROL



≥ 65 CM



EASY  
INSTALLATION



LED LAMP

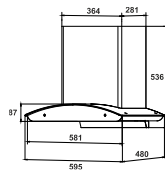

## BAFFLE FILTER WITH HEAT AUTO CLEAN KITCHENHOOD



### WD TBF HAC 90 MS NERO

**Size :** 90 cm  
**Filter:** Baffle  
**Max Air Flow:** 1425 m3/h  
**Control:** 3 Speed Motion  
**Finish:** Black  
**Lighting:** LED 2 X 2W  
**Oil Collector, Easy to Clean**  
**Heat Auto Clean**



MOTION  
CONTROL



≥ 65 CM



EASY  
INSTALLATION



LED LAMP

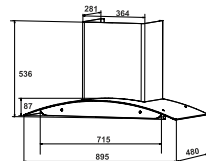

## BAFFLE FILTER WITH HEAT AUTO CLEAN KITCHENHOOD



### WDAT HAC NERO

|               |              |
|---------------|--------------|
| Size :        | 60 / 90 cm   |
| Filter:       | Baffle       |
| Max Air Flow: | 1200 m3/h    |
| Control:      | Touch        |
| Finish:       | Black        |
| Lighting:     | LED 1 X 1.5W |

**Heat Auto Clean**

**Also available with Motion Control**



≥ 65 CM



EASY  
INSTALLATION



LED LAMP

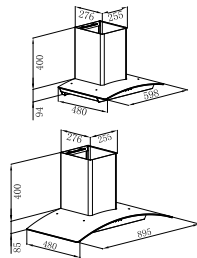

## BAFFLE FILTER WITH HEAT AUTO CLEAN KITCHENHOOD



### WDBF 606/906 HAC MS NERO

|               |                |
|---------------|----------------|
| Size :        | 60/90 cm       |
| Filter:       | Baffle         |
| Max Air Flow: | 1200 m3/h      |
| Control:      | 3 Speed Motion |
| Finish:       | Black          |
| Lighting:     | LED 2 X 1.5W   |

Oil Collector, Easy to Clean

**Heat Auto Clean**



MOTION  
CONTROL



≥ 65 CM



EASY  
INSTALLATION



LED LAMP

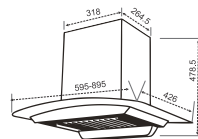



ETB/BAFFLE  
FILTER  
KITCHENHOODS



## ETB WITH BAFFLE FILTER KITCHENHOOD



### METEORITE ETB PLUS LTW T4V LED

|               |                            |
|---------------|----------------------------|
| Size :        | 60/90 cm                   |
| Max Air Flow: | 1220 m <sup>3</sup> /h     |
| Finish:       | SS + Black with Gray Glass |
| Filter:       | Baffle                     |
| Control:      | Touch T4V                  |
| Lighting:     | LED 2 x 2W                 |



≥ 65 CM



EASY  
INSTALLATION



LED LAMP

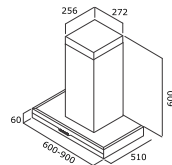



## ETB WITH BAFFLE FILTER KITCHENHOOD



### GLACE TRIM ETB PLUS LTW 903 T4V LED

|               |                             |
|---------------|-----------------------------|
| Size :        | 90 cm                       |
| Max Air Flow: | 1220 m <sup>3</sup> /h      |
| Finish:       | SS + with Transparent Glass |
| Filter:       | 3 Baffle                    |
| Control:      | Touch T4V                   |
| Lighting:     | LED 2 x 1.5W                |



≥ 65 CM



EASY  
INSTALLATION



LED LAMP

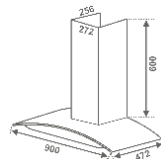

## ETB WITH BAFFLE FILTER KITCHENHOOD



### GALAXY ETB PLUS LTW T4V LED

Size : 60 / 90 cm

Max Air Flow: 1220 m3/h

Finish: SS + Black Glass

Filter: Baffle

Control: Touch T4V

Lighting: LED 2 x 1.5W



≥ 65 CM



EASY  
INSTALLATION



LED LAMP

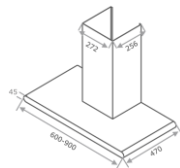

## ETB WITH BAFFLE FILTER KITCHENHOOD



### GLACE SF ETB PLUS LTW 60 NERO

|               |              |
|---------------|--------------|
| Size :        | 60 cm        |
| Filter:       | Baffle       |
| Max Air Flow: | 1220 m3/h    |
| Control:      | Push Button  |
| Finish:       | Black        |
| Lighting:     | LED 2 x 1.5W |



≥ 65 CM



EASY  
INSTALLATION



LED LAMP

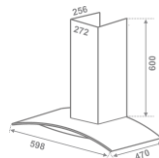

## ETB WITH BAFFLE FILTER KITCHENHOOD



### GLASS TRIM ETB PLUS LTW 60

|               |                        |
|---------------|------------------------|
| Size :        | 60 cm                  |
| Max Air Flow: | 1220 m <sup>3</sup> /h |
| Control:      | Touch T4V              |
| Filter:       | Baffle                 |
| Finish:       | Black/Stainless Steel  |
| Lighting:     | LED 2 x 2W             |



≥ 65 CM



EASY  
INSTALLATION



LED LAMP

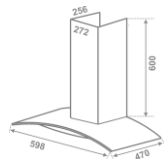

## ETB WITH BAFFLE FILTER KITCHENHOOD



### GLACE TF ETB PLUS LTW 60

|               |                        |
|---------------|------------------------|
| Size :        | 60 cm                  |
| Max Air Flow: | 1220 m <sup>3</sup> /h |
| Control:      | Push Button            |
| Filter:       | Baffle                 |
| Finish:       | Black/Stainless Steel  |
| Lighting:     | LED 2 x 2W             |



≥ 65 CM



EASY  
INSTALLATION



LED LAMP

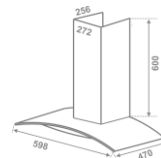

## BAFFLE FILTER KITCHENHOOD



### ESCG BF 60 NERO

|               |                        |
|---------------|------------------------|
| Size :        | 60 cm                  |
| Max Air Flow: | 1100 m <sup>3</sup> /h |
| Control:      | Push Button            |
| Filter:       | Baffle                 |
| Finish:       | Black                  |
| Lighting:     | LED 2 x 1.5W           |



≥ 65 CM



EASY  
INSTALLATION



LED LAMP

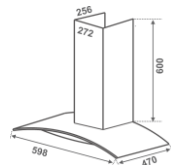

## BAFFLE FILTER KITCHENHOOD



### STRIP BF 60 NERO

|               |                       |
|---------------|-----------------------|
| Size :        | 60 cm                 |
| Max Air Flow: | 880 m <sup>3</sup> /h |
| Filter:       | Baffle                |
| Control:      | Push Button           |
| Lighting:     | LED                   |
| Finish:       | Black                 |

**Also available in Stainless Steel Finish**



≥ 65 CM



EASY  
INSTALLATION



LED LAMP

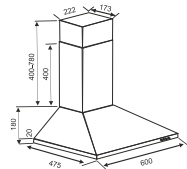

## BAFFLE FILTER KITCHENHOOD

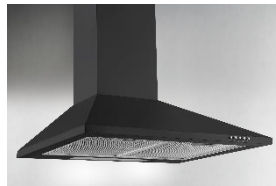

### STRIP CF 60 NERO

|               |                       |
|---------------|-----------------------|
| Size :        | 60 cm                 |
| Max Air Flow: | 880 m <sup>3</sup> /h |
| Filter:       | Cassette              |
| Control:      | Push Button           |
| Lighting:     | LED                   |
| Finish:       | Black                 |

**Also available in Stainless Steel Finish**



≥ 65 CM



EASY  
INSTALLATION



LED LAMP

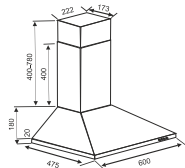



## BAFFLE FILTER KITCHENHOOD



### DH 260 NERO

|               |                        |
|---------------|------------------------|
| Size :        | 60 cm                  |
| Max Air Flow: | 1100 m <sup>3</sup> /h |
| Filter:       | Baffle                 |
| Control:      | Push Button            |
| Lighting:     | LED                    |
| Finish:       | Black                  |

**Also available in Stainless Steel Finish**



≥ 65 CM



EASY  
INSTALLATION



LED LAMP

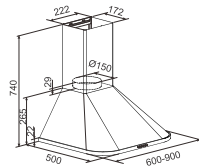

## BAFFLE FILTER KITCHENHOOD



### AH 260 BF

|               |                       |
|---------------|-----------------------|
| Size :        | 60 cm                 |
| Max Air Flow: | 1100 m3/h             |
| Finish:       | Stainless Steel/Black |
| Filter:       | Baffle                |
| Control:      | Push Button           |
| Lighting:     | LED                   |



≥ 65 CM



EASY  
INSTALLATION



LED LAMP

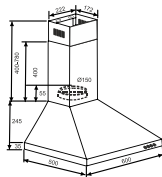

## BAFFLE FILTER KITCHENHOOD



### FS 301

|               |                       |
|---------------|-----------------------|
| Size :        | 60 cm                 |
| Max Air Flow: | 710 m <sup>3</sup> /h |
| Lighting:     | Incandescent          |
| Filter:       | Baffle                |
| Control:      | Push Button           |
| Finish:       | Stainless Steel/Black |



≥ 65 CM



EASY  
INSTALLATION

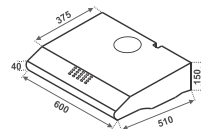

## BAFFLE FILTER KITCHENHOOD

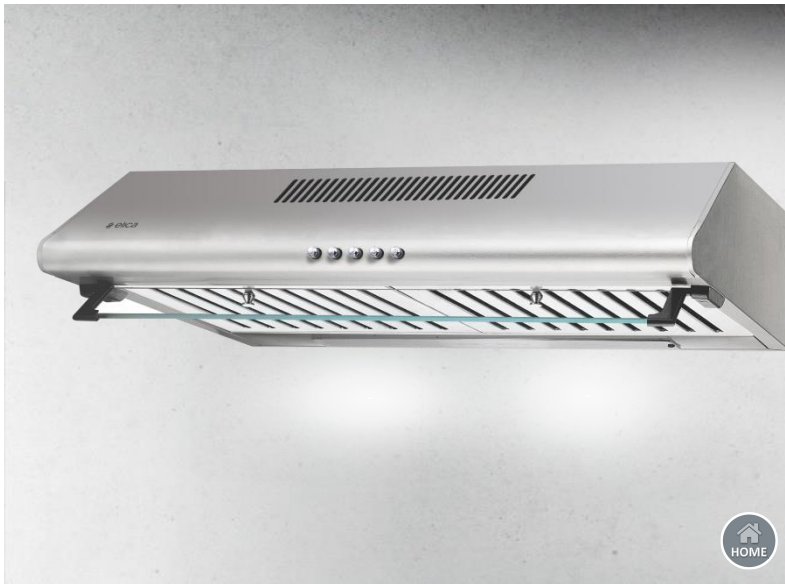

### CBF 602

|               |                       |
|---------------|-----------------------|
| Size :        | 60 cm                 |
| Max Air Flow: | 670 m <sup>3</sup> /h |
| Lighting:     | LED 1 x 2W            |
| Filter:       | Baffle                |
| Control:      | Push Button           |
| Finish:       | Stainless Steel/Black |



≥ 65 CM



EASY  
INSTALLATION



LED LAMP

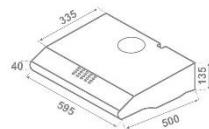

## BAFFLE FILTER KITCHENHOOD

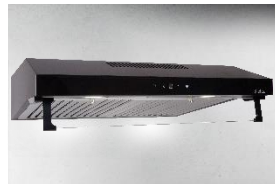

### TNT 602 TOUCH BK

|               |                       |
|---------------|-----------------------|
| Size:         | 60 cm                 |
| Max Air Flow: | 670 m <sup>3</sup> /h |
| Lighting:     | LED 2 x 1.5W          |
| Filter:       | Baffle                |
| Control:      | Touch                 |
| Finish:       | Black                 |



≥ 65 CM



EASY  
INSTALLATION



LED LAMP

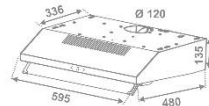

BUILT-IN  
HOBS





MULTI-FLAME CONTROL  
DFS (DIRECT FLAME) SERIES

ELEVATE  
YOUR  
KITCHEN  
STATUS







# DFS (DIRECT FLAME) BUILT-IN HOB



FULL BRASS BURNERS



FLAME FROM TOP WITH HIGH EFFICIENCY



HEAVY DUTY CAST IRON GRID WITH HEAT PROTECTION  
GUARD TO AVOID KNOB HEATING

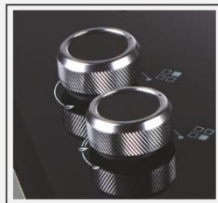

DESIGNER METALLIC KNOBS

## DFS (DIRECT FLAME) SERIES HOB



**Full Brass Heavy Duty Direct Multi-flame burners**  
Built-in Hobs



### DFS FB MFC 3B 70 DX

Built In Hob - 3 Burner 70 cm  
Auto Electric Ignition  
Round Metallic Designer Knobs  
**Full Brass Heavy Duty Direct Multi-flame burners**  
**Fully Sealed Burner Cups with Vertical Injector**  
**Cast Iron Pan Support with Heat Guard**  
**5 Years warranty on Glass, Burner & Valves**

**Full Brass Burners :**  
Heavy Duty Direct Multi-flame burners - 4.3 kw x 2  
Heavy Duty Direct Triple Ring burner - 2.9 kw x 1  
Total Burner Power - 11.5 kw

Product Size mm (W x D x H) 700 x 525 x 123  
Cutting Size mm (W x D x H) 645 x 475 x 55

**Also available with Flame Failure Safety Device (FFD)**

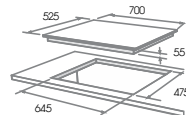

## DFS (DIRECT FLAME) SERIES HOB



**Full Brass Heavy Duty Direct Multi-flame burners**  
Built-in Hobs



### DFS FB MFC 4B 70 DX

Built In Hob - 4 Burner 70 cm  
Auto Electric Ignition  
Round Metallic Designer Knobs  
**Full Brass Heavy Duty Direct Multi-flame burners**  
**Fully Sealed Burner Cups with Vertical Injector**  
**Cast Iron Pan Support with Heat Guard**  
**5 Years warranty on Glass, Burner & Valves**

#### **Full Brass Burners :**

Heavy Duty Direct Multi-flame burners - 4.3 kw x 2  
Heavy Duty Direct Triple Ring burners - 2.9 kw x 2  
Total Burner Power - 14.4 kw

Product Size mm (W x D x H) 700 x 525 x 123

Cutting Size mm (W x D x H) 645 x 475 x 55

**Also available with Flame Failure Safety Device (FFD)**

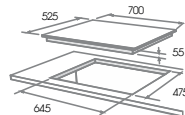

## DFS (DIRECT FLAME) SERIES HOB



**Full Brass Heavy Duty Direct Multi-flame burners**  
Built-in Hobs



### DFS FB MFC 3B 90 DX

Built In Hob - 3 Burner 90 cm  
Auto Electric Ignition  
Round Metallic Designer Knobs  
**Full Brass Heavy Duty Direct Multi-flame burners**  
**Fully Sealed Burner Cups with Vertical Injector**  
**Cast Iron Pan Support with Heat Guard**  
**5 Years warranty on Glass, Burner & Valves**

#### Full Brass Burners :

Heavy Duty Direct Multi-flame burners - 4.3 kw x 2  
Heavy Duty Direct Triple Ring burner - 2.9 kw x 1  
Total Burner Power - 11.5 kw

Product Size mm (W x D x H) 900 x 425 x 123

Cutting Size mm (W x D x H) 860 x 385 x 55

**Also available with Flame Failure Safety Device (FFD)**

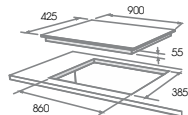

## DFS (DIRECT FLAME) SERIES HOB



**Full Brass Heavy Duty Direct Multi-flame burners**  
Built-in Hobs



### DFS FB MFC 4B 91 DX

Built In Hob - 4 Burner 90 cm  
Auto Electric Ignition  
Round Metallic Designer Knobs  
**Full Brass Heavy Duty Direct Multi-flame burners**  
**Fully Sealed Burner Cups with Vertical Injector**  
**Cast Iron Pan Support with Heat Guard**  
**5 Years warranty on Glass, Burner & Valves**

#### **Full Brass Burners :**

Heavy Duty Direct Multi-flame burners - 4.3 kw x 2  
Heavy Duty Direct Triple Ring burners - 2.9 kw x 2  
Total Burner Power - 14.4 kw

Product Size mm (W x D x H) 900 x 525 x 123

Cutting Size mm (W x D x H) 795 x 485 x 55

**Also available with Flame Failure Safety Device (FFD)**

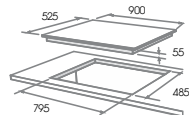

## DFS (DIRECT FLAME) SERIES FLEXI HOB-TOP



Full Brass Heavy Duty Direct Multi-flame burners  
Flexi Hob-Top



### FLEXI DFS FB 3B 75 DX

Flexi Hob-Top - 3 Burner 75 cm

Auto Ignition (Battery Operated)

Round Metallic Designer Knobs

**Full Brass Heavy Duty Direct Multi-flame burners**

**Fully Sealed Burner Cups with Vertical Injector**

**Cast Iron Pan Support with Heat Guard**

**5 Years warranty on Glass, Burner & Valves**

#### Full Brass Burners :

Heavy Duty Direct Triple Ring burners - 2.9 kw x 2

Heavy Duty Direct Double Ring burner – 1.7 kw x 1

Total Burner Power - 7.5 kw

Product Size mm (W x D x H)- 750 x 450 x 106

Cutting Size mm (W x D x H)- 715 x 414 x 50

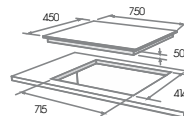

## DFS (DIRECT FLAME) SERIES FLEXI HOB-TOP



Full Brass Heavy Duty Direct Multi-flame burners  
Flexi Hob-Top



### FLEXI DFS FB 4B 70 TX

Flexi Hob-Top - 4 Burner 70 cm  
Auto Ignition (Battery Operated)  
Round Metallic Designer Knobs

**Full Brass Heavy Duty Direct Multi-flame burners**  
**Fully Sealed Burner Cups with Vertical Injector**  
**Cast Iron Pan Support with Heat Guard**  
**5 Years warranty on Glass, Burner & Valves**

#### Full Brass Burners :

Heavy Duty Direct Triple Ring burners - 2.9 kw x 3  
Heavy Duty Double Ring burner – 1.7 kw x 1  
Total Burner Power - 10.4 kw

Product Size mm (W x D x H)- 700 x 520 x 106

Cutting Size mm (W x D x H)- 660 x 480 x 50

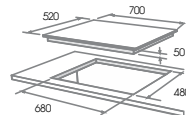

## DFS (DIRECT FLAME) SERIES FLEXI HOB-TOP



Full Brass Heavy Duty Direct Multi-flame burners  
Flexi Hob-Top



### FLEXI DFS FB 4B 90 TX

Flexi Hob-Top - 4 Burner 70 cm  
Auto Ignition (Battery Operated)  
Round Metallic Designer Knobs  
**Full Brass Heavy Duty Direct Multi-flame burners**  
**Fully Sealed Burner Cups with Vertical Injector**  
**Cast Iron Pan Support with Heat Guard**  
**5 Years warranty on Glass, Burner & Valves**

#### Full Brass Burners :

Heavy Duty Direct Triple Ring burners - 2.9 kw x 3  
Heavy Duty Double Ring burner – 1.7 kw x 1  
Total Burner Power - 10.4 kw

Product Size mm (W x D x H) 900 x 525 x 120  
Cutting Size mm (W x D x H) 860 x 485 x 55

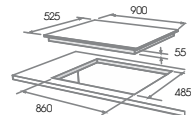



## DFS SERIES SQUARE CAST IRON GRID FLEXI HOB-TOP

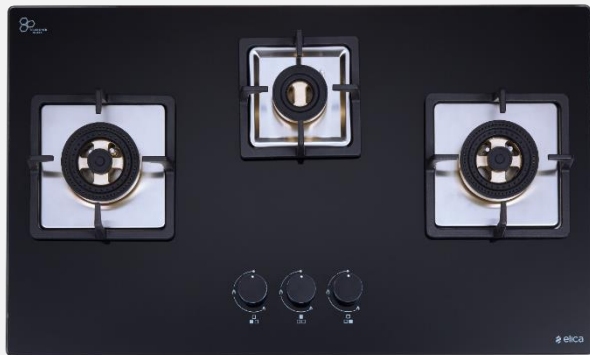

Full Brass Heavy Duty Direct Multi-flame burners  
Flexi Hob-Top



### IND FLEXI FB 375 DX DFS

Flexi Hob-Top - 3 Burner 75 cm  
Auto Ignition (Battery Operated)  
Round Metallic Knobs

**Full Brass Heavy Duty Direct Multi-flame burners**  
**Fully Sealed Burner Cups with Vertical Injector**  
**Cast Iron Pan Support**  
**5 Years warranty on Glass, Burner & Valves**

#### Full Brass Burners :

Heavy Duty Direct Triple Ring burners - 2.9 kw x 2  
Heavy Duty Direct Double Ring burner - 1.7 kw x 1  
Total Burner Power - 7.5 kw

Product dimension (w x d x h) 750 x 450 x 106

Cutting dimension (w x d x h) 715 x 414 x 50

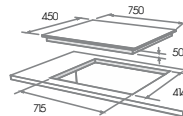

## DFS SERIES SQUARE CAST IRON GRID FELXI HOB-TOP



Full Brass Heavy Duty Direct Multi-flame burners  
Flexi Hob-Top



### IND FLEXI FB 470 DX DFS

Flexi Hob-Top - 4 Burner 70 cm

Auto Ignition (Battery Operated)

Round Metallic Knobs

**Full Brass Heavy Duty Direct Multi-flame burners**

**Fully Sealed Burner Cups with Vertical Injector**

**Cast Iron Pan Support**

**5 Years warranty on Glass, Burner & Valves**

#### Full Brass Burners :

Heavy Duty Direct Triple Ring burners - 2.9 kw x 2

Heavy Duty Direct Double Ring burner - 1.7 kw x 2

Total Burner Power - 9.2 kw

Product dimension (w x d x h) 700 x 520 x 106

Cutting dimension (w x d x h) 660 x 480 x 50

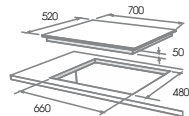

## DFS SERIES SQUARE CAST IRON GRID FLEXI HOB-TOP



Full Brass Heavy Duty Direct Multi-flame burners  
Flexi Hob-Top



### IND FLEXI FB 491 DX DFS

Flexi Hob-Top - 4 Burner 90 cm  
Auto Ignition (Battery Operated)  
Round Metallic Knobs

**Full Brass Heavy Duty Direct Multi-flame burners**  
**Fully Sealed Burner Cups with Vertical Injector**  
**Cast Iron Pan Support**  
**5 Years warranty on Glass, Burner & Valves**

#### Full Brass Burners :

Heavy Duty Direct Triple Ring burners - 2.9 kw x 2  
Heavy Duty Direct Double Ring burner – 1.7 kw x 2  
Total Burner Power - 9.2 kw

Product dimension (w x d x h) 900 x 525 x 120

Cutting dimension (w x d x h) 860 x 485 x 55

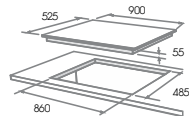



MULTI-FLAME CONTROL  
PRO SERIES

BEHIND EVERY  
GREAT CHEF,  
THERE'S A  
STRONG AND  
SMART KITCHEN





## PRO MAX FB SERIES HOB



**Full Brass Heavy Duty Multi-flame burners**  
Built-in Hobs



### PRO MAX FB MFC 3B 70 DX FFD

Built In Hob - 3 Burner 70 cm  
Auto Electric Ignition  
Cast iron pan support with Matt Enamelled  
Round Metallic Designer Knobs  
**Full Brass Heavy Duty Multi-flame burners**  
**Flame Failure Safety Device (FFD)**  
**Pro Max Burner power 5 kw**  
**Pro Max Burner diameter 140 mm**  
**5 Years warranty on Glass, Gas Valves**

#### **Full Brass Burners :**

Heavy Duty Multi-Flame Control Burners – 5 kw x 2  
Heavy Duty Double Ring Burner - 1.7 kw x 1  
Total Burner Power – 11.7 kw

Product Size mm (W x D x H) 700 x 525 x 123

Cutting Size mm (W x D x H) 645 x 475 x 55

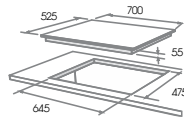

## PRO MAX FB SERIES HOB



Full Brass Heavy Duty Multi-flame burners  
Built-in Hobs



### PRO MAX FB MFC 3B 75 DX FFD

Built In Hob - 3 Burner 75 cm  
Auto Electric Ignition  
Cast iron pan support with Matt Enamelled  
Round Metallic Designer Knobs  
**Full Brass Heavy Duty Multi-flame burners**  
**Flame Failure Safety Device (FFD)**  
**Pro Max Burner power 5 kw**  
**Pro Max Burner diameter 140 mm**

#### Full Brass Burners :

Heavy Duty Multi-Flame Control Burners – 5 kw x 2  
Heavy Duty Double Ring Burner - 1.7 kw x 1  
Total Burner Power – 11.7 kw

Product Size mm (W x D x H) 750 x 450 x 123  
Cutting Size mm (W x D x H) 710 x 410 x 55

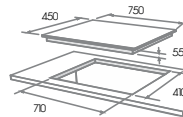

## PRO MAX FB SERIES HOB

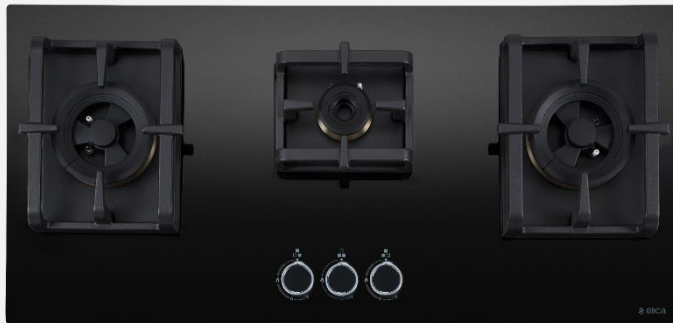

### PRO MAX FB MFC 3B 90 DX FFD

Built In Hob - 3 Burner 90 cm

Auto Electric Ignition

Cast iron pan support with Matt Enamelled

Round Metallic Designer Knobs

**Full Brass Heavy Duty Multi-flame burners**

**Flame Failure Safety Device (FFD)**

**Pro Max Burner power 5 kw**

**Pro Max Burner diameter 140 mm**

**Full Brass Burners :**

Heavy Duty Multi-Flame Control Burners – 5 kw x 2

Heavy Duty Double Ring Burner - 1.7 kw x 1

Total Burner Power – 11.7 kw

Product Size mm (W x D x H) 900 x 425 x 123

Cutting Size mm (W x D x H) 860 x 385 x 55

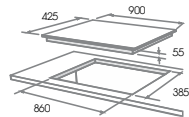

**Full Brass Heavy Duty Multi-flame burners**  
**Built-in Hobs**





## PRO MAX FB SERIES HOB



Full Brass Heavy Duty Multi-flame burners  
Built-in Hobs



### PRO MAX FB MFC 4B 91 DX FFD

Built In Hob - 4 Burner 90 cm  
Auto Electric Ignition  
Cast iron pan support with Matt Enamelled  
Round Metallic Designer Knobs  
**Full Brass Heavy Duty Multi-flame burners**  
**Flame Failure Safety Device (FFD)**  
**Pro Max Burner power 5 kw**  
**Pro Max Burner diameter 140 mm**

#### Full Brass Burners :

Heavy Duty Multi-Flame Control Burners – 5 kw x 2  
Heavy Duty Triple Ring Burner – 2.9 kw x 1  
Heavy Duty Double Ring Burner - 1.7 kw x 1  
Total Burner Power – 14.2 kw

Product Size mm (W x D x H) 900 x 525 x 123

Cutting Size mm (W x D x H) 795 x 485 x 55

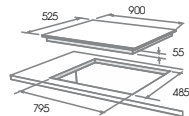

## PRO MAX FB SERIES HOB



**Full Brass Heavy Duty Multi-flame burners**  
**Built-in Hobs**



### PRO MAX FB MFC 4B 70 DX FFD

Built In Hob - 4 Burner 70 cm  
 Auto Electric Ignition  
 Cast iron pan support with Matt Enamelled  
 Round Metallic Designer Knobs  
**Full Brass Heavy Duty Multi-flame burners**  
**Flame Failure Safety Device (FFD)**  
**Pro Max Burner power 5 kw**  
**Pro Max Burner diameter 140 mm**

#### Full Brass Burners :

Heavy Duty Multi-Flame Control Burners – 5 kw x 2  
 Heavy Duty Double Ring Burner - 1.7 kw x 2  
 Total Burner Power – 13.4 kw

Product Size mm (W x D x H) 700 x 525 x 123  
 Cutting Size mm (W x D x H) 645 x 475 x 55

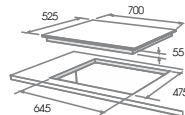

## PRO MAX FB SERIES HOB



### PRO MAX FB MFC 4B 100 DX FFD

Built In Hob - 4 Burner 100 cm  
 Auto Electric Ignition  
 Cast iron pan support with Matt Enamelled  
 Round Metallic Designer Knobs  
**Full Brass Heavy Duty Multi-flame burners**  
**Flame Failure Safety Device (FFD)**  
**Pro Max Burner power 5 kw**  
**Pro Max Burner diameter 140 mm**

#### Full Brass Burners :

Heavy Duty Multi-Flame Control Burners – 5 kw x 2  
 Heavy Duty Double Ring Burner - 1.7 kw x 2  
 Total Burner Power – 13.4 kw

Product Size mm (W x D x H) 1000 x 450 x 123  
 Cutting Size mm (W x D x H) 956 x 410 x 55

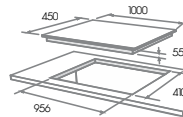

**Full Brass Heavy Duty Multi-flame burners**  
**Built-in Hobs**



## PRO MAX FB SERIES HOB



**Full Brass Heavy Duty Multi-flame burners**  
**Built-in Hobs**



### PRO MAX FB MFC 4B 120 DX FFD

Built In Hob - 4 Burner 120 cm  
 Auto Electric Ignition  
 Cast iron pan support with Matt Enamelled  
 Round Metallic Designer Knobs  
**Full Brass Heavy Duty Multi-flame burners**  
**Flame Failure Safety Device (FFD)**  
**Pro Max Burner power 5 kw**  
**Pro Max Burner diameter 140 mm**

#### Full Brass Burners :

Heavy Duty Multi-Flame Control Burners – 5 kw x 2  
 Heavy Duty Double Ring Burner - 1.7 kw x 2  
 Total Burner Power – 13.4 kw

Product Size mm (W x D x H) 1200 x 400 x 123  
 Cutting Size mm (W x D x H) 1113 x 362 x 55

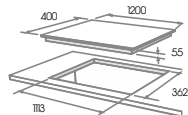

## PRO FB SERIES HOB



Full Brass Heavy Duty Multi-flame burners  
Built-in Hobs



### PRO FB MFC 1B 30 FFD

Built In Hob - 1 Burner 30 cm  
Auto Ignition (Battery Operated)  
Round Metallic Knobs  
Cast iron pan support with Matt Enamelled  
**Full Brass Heavy Duty Multi-flame burner**  
**Flame Failure Safety Device (FFD)**  
**Ignition Plug with Brass Sleeve**  
**5 Years warranty on Glass, Burner & Valves**

#### Full Brass Burners :

Heavy Duty Multi-Flame Control Burner – 4 kw x 1  
Total Burner Power – 4 kw

Product Size mm (W x D x H) 300 x 498 x 123

Cutting Size mm (W x D x H) 265 x 460 x 55

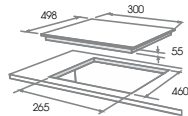

## PRO FB SERIES HOB



Full Brass Heavy Duty Multi-flame burners  
Built-in Hobs



### PRO FB MFC 3B 70 DX FFD

Built In Hob - 3 Burner 70 cm  
Auto Electric Ignition  
Round Metallic Knobs  
Cast iron pan support with Matt Enamelled  
**Full Brass Heavy Duty Multi-flame burner**  
**Flame Failure Safety Device (FFD)**  
**Ignition Plug with Brass Sleeve**  
**5 Years warranty on Glass, Burner & Valves**

#### Full Brass Burners :

Heavy Duty Multi-Flame Control Burners – 4 kw x 2  
Heavy Duty Double Ring Burner - 1.7 kw x 1  
Total Burner Power – 9.7 kw

Product Size mm (W x D x H) 700 x 525 x 123  
Cutting Size mm (W x D x H) 645 x 475 x 55

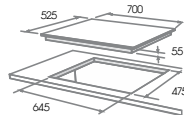

## PRO FB SERIES HOB



**Full Brass Heavy Duty Multi-flame burners**  
**Built-in Hobs**



### PRO FB MFC 4B 70 DX FFD

Built In Hob - 4 Burner 70 cm  
 Auto Electric Ignition  
 Round Metallic Knobs  
 Cast iron pan support with Matt Enamelled  
**Full Brass Heavy Duty Multi-flame burner**  
**Flame Failure Safety Device (FFD)**  
**Ignition Plug with Brass Sleeve**  
**5 Years warranty on Glass, Burner & Valves**

#### **Full Brass Burners :**

Heavy Duty Multi-Flame Control Burners – 4 kw x 2  
 Heavy Duty Double Ring Burner - 1.7 kw x 2  
 Total Burner Power – 11.4 kw

Product Size mm (W x D x H) 700 x 525 x 123  
 Cutting Size mm (W x D x H) 645 x 475 x 55

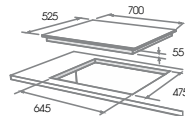

## PRO FB SERIES HOB



Full Brass Heavy Duty Multi-flame burners  
Built-in Hobs



### PRO FB MFC 3B 75 DX FFD

Built In Hob - 3 Burner 75 cm

Auto Electric Ignition

Round Metallic Knobs

Cast iron pan support with Matt Enamelled

**Full Brass Heavy Duty Multi-flame burner**

**Flame Failure Safety Device (FFD)**

**Ignition Plug with Brass Sleeve**

**5 Years warranty on Glass, Burner & Valves**

#### Full Brass Burners :

Heavy Duty Multi-Flame Control Burners – 4 kw x 2

Heavy Duty Double Ring Burner - 1.7 kw x 1

Total Burner Power – 9.7 kw

Product Size mm (W x D x H) 750 x 450 x 123

Cutting Size mm (W x D x H) 710 x 410 x 55

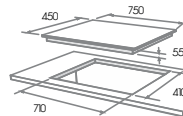



## PRO FB SERIES HOB



### PRO FB MFC 4B 91 DX FFD

Built In Hob - 4 Burner 90 cm  
 Auto Electric Ignition  
 Round Metallic Knobs  
 Cast iron pan support with Matt Enamelled  
**Full Brass Heavy Duty Multi-flame burner**  
**Flame Failure Safety Device (FFD)**  
**Ignition Plug with Brass Sleeve**  
**5 Years warranty on Glass, Burner & Valves**

#### Full Brass Burners :

Heavy Duty Multi-Flame Control Burners – 4 kw x 2  
 Heavy Duty Triple Ring Burner – 2.9 kw x 1  
 Heavy Duty Double Ring Burner - 1.7 kw x 1  
 Total Burner Power – 12.6 kw

Product Size mm (W x D x H) 900 x 525 x 123

Cutting Size mm (W x D x H) 795 x 485 x 55

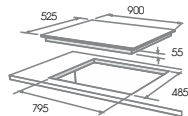

Full Brass Heavy Duty Multi-flame burners  
 Built-in Hobs



## PRO FB SERIES HOB



**Full Brass Heavy Duty Multi-flame burners**  
**Built-in Hobs**



### PRO FB MFC 3B 90 DX FFD

Built In Hob - 3 Burner 90 cm  
 Auto Electric Ignition  
 Round Metallic Knobs  
 Cast iron pan support with Matt Enamelled  
**Full Brass Heavy Duty Multi-flame burner**  
**Flame Failure Safety Device (FFD)**  
**Ignition Plug with Brass Sleeve**  
**5 Years warranty on Glass, Burner & Valves**

#### Full Brass Burners :

Heavy Duty Multi-Flame Control Burners – 4 kw x 2  
 Heavy Duty Double Ring Burner - 1.7 kw x 1  
 Total Burner Power – 9.7 kw

Product Size mm (W x D x H) 900 x 425 x 123  
 Cutting Size mm (W x D x H) 860 x 385 x 55

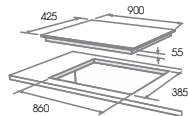

## PRO FB SERIES HOB



### PRO FB MFC 5B 90 MT FFD

Built In Hob - 5 Burner 90 cm  
 Auto Electric Ignition  
 Round Metallic Knobs  
 Cast iron pan support with Matt Enamelled  
**Full Brass Heavy Duty Multi-flame burner**  
**Flame Failure Safety Device (FFD)**  
**Ignition Plug with Brass Sleeve**  
**5 Years warranty on Glass, Burner & Valves**

#### Full Brass Burners :

Heavy Duty Multi-Flame Control Burners – 4 kw x 1  
 Heavy Duty Triple Ring Burner – 2.9 kw x 2  
 Heavy Duty Double Ring Burner - 1.7 kw x 2  
 Total Burner Power – 13.2 kw

Product Size mm (W x D x H) 900 x 525 x 123

Cutting Size mm (W x D x H) 795 x 485 x 55

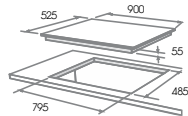

Full Brass Heavy Duty Multi-flame burners  
 Built-in Hobs



## PRO FB SERIES HOB



**Full Brass Heavy Duty Multi-flame burners**  
**Built-in Hobs**



### PRO FB MFC 4B DX 100 FFD

Built In Hob - 4 Burner 100 cm

Auto Electric Ignition

Round Metallic Knobs

Cast iron pan support with Matt Enamelled

**Full Brass Heavy Duty Multi-flame burner**

**Flame Failure Safety Device (FFD)**

**Ignition Plug with Brass Sleeve**

**5 Years warranty on Glass, Burner & Valves**

#### **Full Brass Burners :**

Heavy Duty Multi-Flame Control Burners – 4 kw x 2

Heavy Duty Triple Ring Burner – 2.9 kw x 1

Heavy Duty Double Ring Burner - 1.7 kw x 1

Total Burner Power – 13.2 kw

Product Size mm: (W x D x H) 1000 x 450 x 123

Cutting Size mm: (W x D x H) 956 x 410 x 55

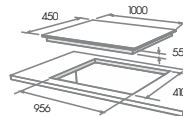

## PRO FB SERIES HOB



**Full Brass Heavy Duty Multi-flame burners**  
**Built-in Hobs**



### PRO FB MFC 4B DX 120 FFD

Built In Hob - 4 Burner 120 cm  
 Auto Electric Ignition  
 Round Metallic Knobs  
 Cast iron pan support with Matt Enamelled  
**Full Brass Heavy Duty Multi-flame burner**  
**Flame Failure Safety Device (FFD)**  
**Ignition Plug with Brass Sleeve**  
**5 Years warranty on Glass, Burner & Valves**

#### Full Brass Burners :

Heavy Duty Multi-Flame Control Burners – 4 kw x 2  
 Heavy Duty Triple Ring Burner – 2.9 kw x 1  
 Heavy Duty Double Ring Burner - 1.7 kw x 1  
 Total Burner Power – 13.2 kw

Product Size mm: (W x D x H) 1200 x 400 x 123

Cutting Size mm: (W x D x H) 1113 x 362 x 55

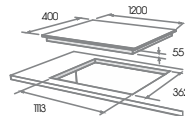

## PRO MFC SWIRL SERIES HOB



Multi-flame Control Brass burners  
Built-in Hobs



### PRO MFC 1B 30 FFD

Built In Hob - 1 Burner 30 cm  
Auto Electric Ignition (Battery Operated)  
Round Metallic Knob  
Cast iron pan support with Matt Enamelled  
**Multi Flame Control Brass Burner**  
**Flame Failure Safety Device FFD**  
**5 Years warranty on Glass & Valves**

#### Brass Burner :

Multi-Flame Control Burner – 4 kw x 1  
Total Burner Power – 4 kw

Product Size mm (W x D x H) 300 x 498 x 123

Cutting Size mm (W x D x H) 265 x 460 x 55

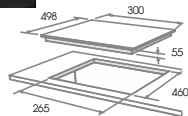

## PRO MFC SWIRL SERIES HOB



Multi-flame Control Brass burners  
Built-in Hobs



### PRO MFC 3B 70 DX SWIRL

Built In Hob - 3 Burner 70 cm  
Auto Electric Ignition  
Round Metallic Knob  
Cast iron pan support with Matt Enamelled  
**Multi Flame Control Brass Burner**  
**5 Years warranty on Glass & Valves**

#### Brass Burner :

Multi-Flame Control Burner – 4 kw x 2  
Multi-Flame Control Burner – 2.2 kw x 1  
Total Burner Power – 10.2 kw

Product Size mm (W x D x H) 700 x 525 x 123  
Cutting Size mm (W x D x H) 645 x 475 x 55

Also available with Flame Failure Safety Device (FFD)

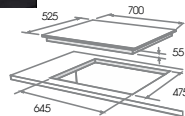

## PRO MFC SWIRL SERIES HOB

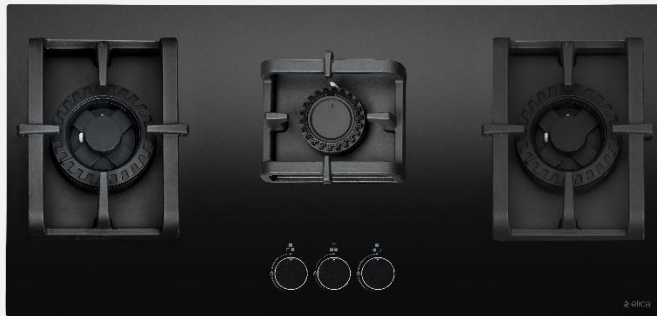

Multi-flame Control Brass burners  
Built-in Hobs



### PRO MFC 3B 90 DX SWIRL

Built In Hob - 3 Burner 90 cm  
Auto Electric Ignition  
Round Metallic Knob  
Cast iron pan support with Matt Enamelled  
**Multi Flame Control Brass Burner**  
**5 Years warranty on Glass & Valves**

#### Brass Burner :

Multi-Flame Control Burner – 4 kw x 2  
Multi-Flame Control Burner – 2.2 kw x 1  
Total Burner Power – 10.2 kw

Product Size mm (W x D x H) 900 x 425 x 123  
Cutting Size Mm (W x D x H) 860 x 385 x 55

Also available with Flame Failure Safety Device (FFD)

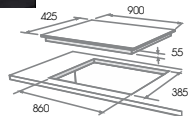



## PRO MFC SWIRL SERIES HOB



Multi-flame Control Brass burners  
Built-in Hobs



## PRO MFC 4B 70 DX SWIRL N

Built In Hob - 4 Burner 70 cm  
Auto Electric Ignition  
Round Metallic Knob  
Cast iron pan support with Matt Enamelled  
**Multi Flame Control Brass Burner**  
**5 Years warranty on Glass & Valves**

### Brass Burner :

Multi-Flame Control Burner – 4 kw x 2  
Heavy Duty 86 mm Swirl Burner – 2.2 kw x 1  
Heavy Duty 70 mm Swirl Burner – 1.5 kw x 1  
Total Burner Power – 11.7 kw

Product Size mm (W x D x H) 700 x 525 x 123  
Cutting Size mm (W x D x H) 645 x 475 x 55

Also available with Flame Failure Safety Device (FFD)

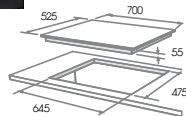

## PRO MFC SWIRL SERIES HOB



Multi-flame Control Brass burners  
Built-in Hobs



### PRO MFC 4B 91 DX SWIRL N

Built In Hob - 4 Burner 90 cm  
Auto Electric Ignition  
Round Metallic Knob  
Cast iron pan support with Matt Enamelled  
**Multi Flame Control Brass Burner**  
**5 Years warranty on Glass & Valves**

#### Brass Burner :

Multi-Flame Control Burner – 4 kw x 2  
Heavy Duty 86 mm Swirl Burner – 2.2 kw x 1  
Heavy Duty 70 mm Swirl Burner – 1.5 kw x 1  
Total Burner Power – 11.7 kw

Product Size mm (W x D x H) 900 x 525 x 123  
Cutting Size mm (W x D x H) 795 x 485 x 55

Also available with Flame Failure Safety Device (FFD)

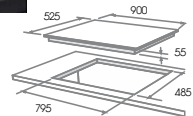

## PRO MFC SWIRL SERIES HOB



Multi-flame Control Brass burners  
Built-in Hobs



### PRO MFC 5B 90 SWIRL

Built In Hob - 5 Burner 90 cm  
Auto Electric Ignition  
Round Metallic Knob  
Cast iron pan support with Matt Enamelled  
**Multi Flame Control Brass Burner**  
**5 Years warranty on Glass & Valves**

#### Brass Burner :

Multi-Flame Control Burner – 4 kw x 1  
Heavy Duty 86 mm Swirl Burner – 2.2 kw x 3  
Heavy Duty 70 mm Swirl Burner – 1.5 kw x 1  
Total Burner Power – 16.4 kw

Product Size mm (W x D x H) 900 x 525 x 123  
Cutting Size mm (W x D x H) 795 x 485 x 55

Also available with Flame Failure Safety Device (FFD)

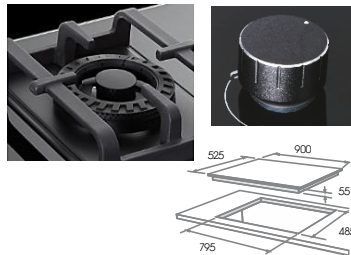

## PRO MFC SWIRL SERIES HOB

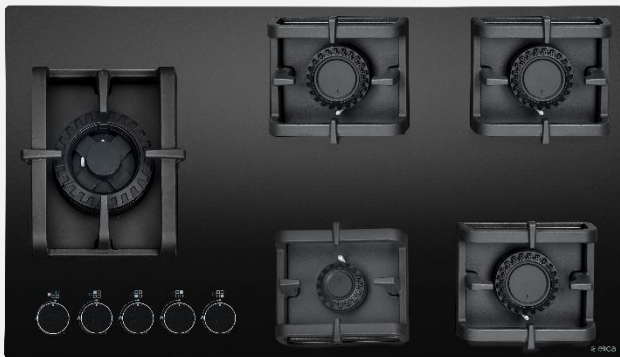

Multi-flame Control Brass burners  
Built-in Hobs



### PRO MFC 5B 91 SWIRL

Built In Hob - 5 Burner 90 cm  
Auto Electric Ignition (Battery Operated)  
Round Metallic Knob  
**Multi Flame Control Brass Burner**  
**5 Years warranty on Glass & Valves**

#### **Burner Burner :**

Multi-Flame Control Burner – 4 kw x 1  
Heavy Duty 86 mm Swirl Burner – 2.2 kw x 3  
Heavy Duty 70 mm Swirl Burner – 1.5 kw x 1  
Total Burner Power – 16.4 kw

Product Size mm (W x D x H) 900 x 525 x 123

Cutting Size mm (W x D x H) 836 x 485 x 55

**Also available with Flame Failure Safety Device (FFD)**

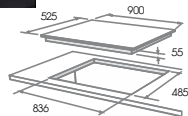

## PRO MFC SWIRL SERIES HOB

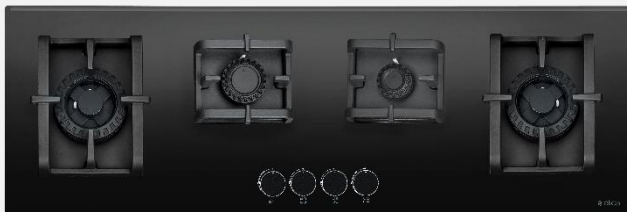

Multi-flame Control Brass burners  
Built-in Hobs



### PRO MFC 4B 100 DX SWIRL

Built In Hob - 4 Burner 100 cm  
Auto Electric Ignition  
Round Metallic Knob  
Cast iron pan support with Matt Enamelled  
**Multi Flame Control Brass Burner**  
**5 Years warranty on Glass & Valves**

#### Brass Burner :

Multi-Flame Control Burner – 4 kw x 2  
Heavy Duty 86 mm Swirl Burner – 2.2 kw x 1  
Heavy Duty 70 mm Swirl Burner – 1.5 kw x 1  
Total Burner Power – 11.7 kw

Product Size (W x D x H) 1000 x 450 x 123  
Cutting Size (W x D x H) 956 x 410 x 55

Also available with Flame Failure Safety Device (FFD)

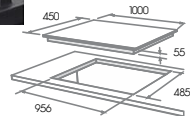

## PRO MFC SWIRL SERIES HOB



Multi-flame Control Brass burners  
Built-in Hobs



### PRO MFC 4B 120 DX SWIRL

Built In Hob - 4 Burner 120 cm  
Auto Electric Ignition  
Round Metallic Knob  
Cast iron pan support with Matt Enamelled  
**Multi Flame Control Brass Burner**  
**5 Years warranty on Glass & Valves**

#### Brass Burner :

Multi-Flame Control Burner – 4 kw x 2  
Heavy Duty 86 mm Swirl Burner – 2.2 kw x 1  
Heavy Duty 70 mm Swirl Burner – 1.5 kw x 1  
Total Burner Power – 11.7 kw

Product Size (W x D x H) 1200 x 400 x 123  
Cutting Size (W x D x H) 1113 x 362 x 55

Also available with Flame Failure Safety Device (FFD)

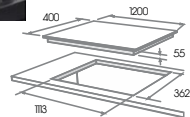

## PRO AB SERIES HOB



Multi-flame Control Advanced Brass burners  
Built-in Hobs



### PRO AB MFC 3B 70 DX

Built In Hob - 3 Burner 70 cm  
Auto Electric Ignition  
Round Metallic Knob  
Cast iron pan support with Matt Enamelled  
**Multi Flame Control Advanced Brass Burner**  
**5 Years warranty on Glass & Valves**

#### Brass Burner :

Heavy Duty Multi-Flame Control Burners – 4 kw x 2  
Heavy Duty Double Ring Burner - 1.7 kw x 1

Total Burner Power – 9.7 kw

Product Size mm (W x D x H) 700 x 525 x 123  
Cutting Size mm (W x D x H) 645 x 475 x 55

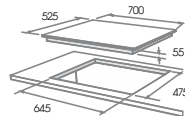

## PRO AB SERIES HOB



Multi-flame Control Advanced Brass burners  
Built-in Hobs



### PRO AB MFC 4B 70 DX

Built In Hob - 4 Burner 70 cm  
Auto Electric Ignition  
Round Metallic Knob  
Cast iron pan support with Matt Enamelled  
**Multi Flame Control Advanced Brass Burner**  
**5 Years warranty on Glass & Valves**

#### Brass Burner :

Heavy Duty Multi-Flame Control Burners – 4 kw x 2  
Heavy Duty Double Ring Burner - 1.7 kw x 2

Total Burner Power – 11.4 kw

Product Size mm (W x D x H) 700 x 525 x 123  
Cutting Size mm (W x D x H) 645 x 475 x 55

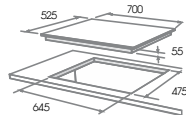



## PRO AB SERIES HOB



Multi-flame Control Advanced Brass burners  
Built-in Hobs



### PRO AB MFC 4B 91 DX

Built In Hob - 4 Burner 90 cm  
Auto Electric Ignition  
Round Metallic Knob  
Cast iron pan support with Matt Enamelled  
**Multi Flame Control Advanced Brass Burner**  
**5 Years warranty on Glass & Valves**

#### Brass Burner :

Heavy Duty Multi-Flame Control Burners – 4 kw x 2  
Heavy Duty Triple Ring Burner – 2.9 kw x 1  
Heavy Duty Double Ring Burner - 1.7 kw x 1  
Total Burner Power – 12.6 kw

Product Size mm (W x D x H) 900 x 525 x 123  
Cutting Size mm (W x D x H) 795 x 485 x 55

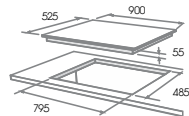

## FLEXI PRO MAX AB SERIES



Multi-flame Control Advanced Brass burners  
Built-in Hobs



### FLEXI PRO MAX AB MFC 3B 70 DX

Flexi Hob-Top - 3 Burner 70 cm  
Auto Ignition (Battery Operated)  
Round Metallic Knobs  
Cast iron pan support with Matt Enamelled  
**Multi Flame Control Advanced Brass Burner**  
Double Enamelled Heavy Duty Cast Iron Grids  
**5 Years warranty on Glass & Valves**

#### Brass Burner :

Heavy Duty Multi-Flame Control Burners – 4.3 kw x 2  
Heavy Duty Double Ring Burner – 1.7 kw x 1  
Total Burner Power – 10.3 kw

Product Size mm (W x D x H) 700 x 525 x 123  
Cutting Size mm (W x D x H) 665 x 485 x 55

#### Dimensions of built-in hob with Electric Auto Ignition

Product dimensions: (w x d x h) 700 x 525 x 123  
Cutting dimensions: (w x d x h) 645 x 475 x 55

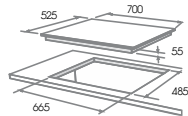
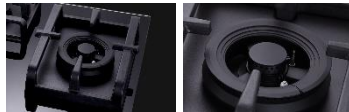

## FLEXI PRO MAX AB SERIES



Multi-flame Control Advanced Brass burners  
Built-in Hobs



### FLEXI PRO MAX AB MFC 4B 70 DX

Flexi Hob-Top - 4 Burner 70 cm  
Auto Ignition (Battery Operated)  
Round Metallic Knobs  
Cast iron pan support with Matt Enamelled  
**Multi Flame Control Advanced Brass Burner**  
Double Enamelled Heavy Duty Cast Iron Grids  
**5 Years warranty on Glass & Valves**

#### Brass Burner :

Heavy Duty Multi-Flame Control Burners – 4.3 kw x 2  
Heavy Duty Double Ring Burner – 1.7 kw x 2  
Total Burner Power – 12 kw

Product Size mm (W x D x H) 700 x 525 x 123  
Cutting Size mm (W x D x H) 665 x 485 x 55

#### Dimensions of built-in hob with Electric Auto Ignition

Product dimensions: (w x d x h) 700 x 525 x 123  
Cutting dimensions: (w x d x h) 645 x 475 x 55

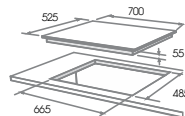
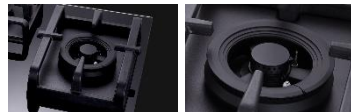

## FLEXI PRO MAX AB SERIES

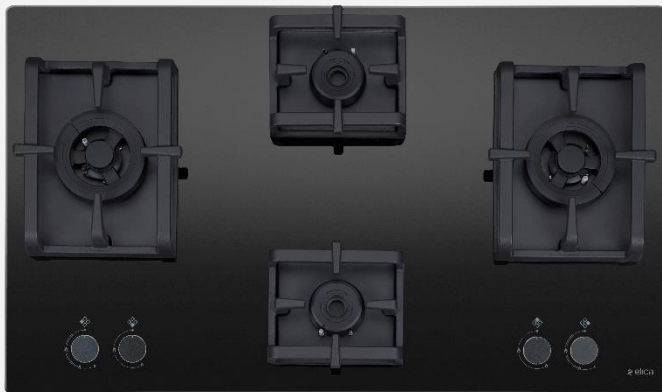

Multi-flame Control Advanced Brass burners  
Built-in Hobs



### FLEXI PRO MAX AB MFC 4B 91 DX

Flexi Hob-Top - 4 Burner 90 cm  
Auto Ignition (Battery Operated)  
Round Metallic Knobs  
Cast iron pan support with Matt Enamelled  
**Multi Flame Control Advanced Brass Burner**  
Double Enamelled Heavy Duty Cast Iron Grids  
**5 Years warranty on Glass & Valves**

#### Brass Burner :

Heavy Duty Multi-Flame Control Burners – 4.3 kw x 2  
Heavy Duty Double Ring Burner – 1.7 kw x 2  
Total Burner Power – 12 kw

Product Size mm (W x D x H) 900 x 525 x 123  
Cutting Size mm (W x D x H) 860 x 485 x 55

#### Dimensions of built-in hob with Electric Auto Ignition

Product dimensions: (w x d x h) 900 x 525 x 123 mm  
Cutting dimensions: (w x d x h) 795 x 485 x 55 mm

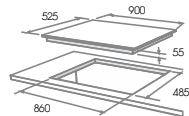

## FLEXI PRO FB SERIES



Full Brass Heavy Duty Multi-ring burners  
Flexi Hob-Top



### FLEXI PRO FB 3B 75 MT DX

Flexi Hob-Top - 3 Burner 75 cm

Auto Ignition (Battery Operated)

Round Metallic Knobs

**Full Brass Heavy Duty Multi-ring Burners**

Cast Iron Pan Support with Matt Enamelling  
**5 Years warranty on Glass, Burner & Valves**

**Full Brass Burners :**

Heavy Duty Triple-ring Burners – 2.9 kw x 2

Heavy Duty Double Ring Burner - 1.7 kw x 1

Total Burner Power – 7.5 kw

Product Size mm (W x D x H) 750 x 450 x 106

Cutting Size mm (W x D x H) 715 x 414 x 50

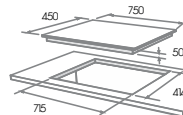

## FLEXI PRO FB SERIES



Full Brass Heavy Duty Multi-ring burners  
Flexi Hob-Top



### FLEXI PRO FB 4B 70 MT DX

Flexi Hob-Top - 4 Burner 75 cm

Auto Ignition (Battery Operated)

Round Metallic Knobs

**Full Brass Heavy Duty Multi-ring Burners**

Cast Iron Pan Support with Matt Enameling

**5 Years warranty on Glass, Burner & Valves**

**Full Brass Burners :**

Heavy Duty Triple-ring Burners – 2.9 kw x 2

Heavy Duty Double Ring Burner - 1.7 kw x 2

Total Burner Power – 9.2 kw

Product Size mm (W x D x H) 700 x 520 x 106

Cutting Size mm (W x D x H) 660 x 480 x 50

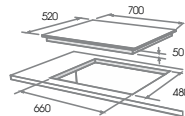

## FLEXI PRO FB SERIES



Full Brass Heavy Duty Multi-ring burners  
Flexi Hob-Top



### FLEXI PRO FB 4B 91 MT DX

Flexi Hob-Top - 4 Burner 90 cm

Auto Ignition (Battery Operated)

Round Metallic Knobs

**Full Brass Heavy Duty Multi-ring Burners**

Cast Iron Pan Support with Matt Enamelling  
**5 Years warranty on Glass, Burner & Valves**

**Full Brass Burners :**

Heavy Duty Triple-ring Burners – 2.9 kw x 2

Heavy Duty Double Ring Burner - 1.7 kw x 2

Total Burner Power – 9.2 kw

Product Size mm (W x D x H) 900 x 525 x 120

Cutting Size mm (W x D x H) 860 x 485 x 55

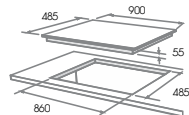



—  
MULTI-FLAME CONTROL  
CLASSIC SERIES  
—

A PERFECT  
FIT FOR  
ANY KITCHEN







## CLASSIC FLEXI FB MFC SERIES



Full Brass Heavy Duty Multi-flame Control burners  
Flexi Hob-Top



### CLASSIC FLEXI FB MFC 3B 60 MT

Flexi Hob-Top - 3 Burner 60 cm  
Auto Ignition (Battery Operated)  
Round Metallic Knobs  
Cast iron pan support with Matt Enamelled  
**Full Brass Heavy Duty Multi-flame burners**  
**5 Years warranty on Glass, Burner & Valves**

#### Full Brass Burners :

Heavy Duty Multi-Flame Control Burner – 4 kw x 1  
Heavy Duty Triple Ring Burner – 2.9 kw x 1  
Heavy Duty Double Ring Burner - 1.7 kw x 1  
Total Burner Power – 8.6 kw

Product Size mm (W x D x H) 600 x 525 x 120  
Cutting Size mm (W x D x H) 565 x 475 x 55

#### Dimensions of Built-in Hob with Electric Auto Ignition

Product dimensions: (w x d x h) 600 x 525 x 120 mm  
Cutting dimensions: (w x d x h) 564 x 485 x 55 mm

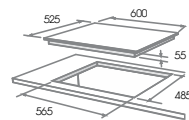

## CLASSIC FLEXI FB MFC SERIES



Full Brass Heavy Duty Multi-flame Control burners  
Flexi Hob-Top



### CLASSIC FLEXI FB MFC 3B 70 MT

Flexi Hob-Top - 3 Burner 70 cm  
Auto Ignition (Battery Operated)  
Round Metallic Knobs  
Cast iron pan support with Matt Enamelled  
**Full Brass Heavy Duty Multi-flame burners**  
**5 Years warranty on Glass, Burner & Valves**

#### Full Brass Burners :

Heavy Duty Multi-Flame Control Burner – 4 kw x 1  
Heavy Duty Triple Ring Burner – 2.9 kw x 1  
Heavy Duty Double Ring Burner - 1.7 kw x 1  
Total Burner Power – 8.6 kw

Product Size mm (W x D x H) 700 x 525 x 120  
Cutting Size mm (W x D x H) 665 x 485 x 55

#### Dimensions of Built-in Hob with Electric Auto Ignition

Product dimensions: (w x d x h) 700 x 525 x 120 mm  
Cutting dimensions: (w x d x h) 645 x 475 x 55 mm

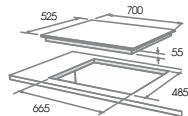
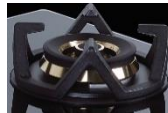

## CLASSIC FLEXI FB MFC SERIES



Full Brass Heavy Duty Multi-flame Control burners  
Flexi Hob-Top



## CLASSIC FLEXI FB MFC 4B 60 MT

Flexi Hob-Top - 4 Burner 60 cm  
Auto Ignition (Battery Operated)  
Round Metallic Knobs  
Cast iron pan support with Matt Enamelled  
**Full Brass Heavy Duty Multi-flame burners**  
**5 Years warranty on Glass, Burner & Valves**

### Full Brass Burners :

Heavy Duty Multi-Flame Control Burner – 4 kw x 1  
Heavy Duty Triple Ring Burner – 2.9 kw x 1  
Heavy Duty Double Ring Burners - 1.7 kw x 2  
Total Burner Power – 10.3 kw

Product Size mm (W x D x H) 600 x 525 x 120  
Cutting Size mm (W x D x H) 565 x 475 x 55

### Dimensions of Built-in Hob with Electric Auto Ignition

Product dimensions: (w x d x h) 600 x 520 x 120 mm  
Cutting dimensions: (w x d x h) 560 x 485 x 55 mm

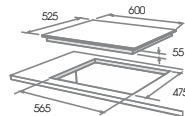

## CLASSIC FLEXI FB MFC SERIES



Full Brass Heavy Duty Multi-flame Control burners  
Flexi Hob-Top

### CLASSIC FLEXI FB MFC 4B 75 MT

Flexi Hob-Top - 4 Burner 75 cm  
Auto Ignition (Battery Operated)  
Round Metallic Knobs  
Cast iron pan support with Matt Enamelled  
**Full Brass Heavy Duty Multi-flame burners**  
**5 Years warranty on Glass, Burner & Valves**

#### Full Brass Burners :

Heavy Duty Multi-Flame Control Burner – 4 kw x 1  
Heavy Duty Triple Ring Burner – 2.9 kw x 1  
Heavy Duty Double Ring Burners - 1.7 kw x 2  
Total Burner Power – 10.3 kw

Product Size mm (W x D x H) 750 x 525 x 120  
Cutting Size mm (W x D x H) 705 x 475 x 55

#### Dimensions of Built-in Hob with Electric Auto Ignition

Product dimensions: (w x d x h) 750 x 525 x 120 mm  
Cutting dimensions: (w x d x h) 705 x 475 x 55 mm

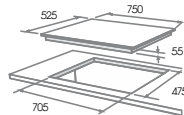

## CLASSIC FLEXI FB MFC SERIES



Full Brass Heavy Duty Multi-flame Control burners  
Flexi Hob-Top



## CLASSIC FLEXI FB MFC 4B 90 R MT

Flexi Hob-Top - 4 Burner 90 cm  
Auto Ignition (Battery Operated)  
Round Metallic Knobs  
Cast iron pan support with Matt Enamelled  
**Full Brass Heavy Duty Multi-flame burners**  
**5 Years warranty on Glass, Burner & Valves**

### Full Brass Burners :

Heavy Duty Multi-Flame Control Burner – 4 kw x 1  
Heavy Duty Triple Ring Burner – 2.9 kw x 1  
Heavy Duty Double Ring Burners - 1.7 kw x 2  
Total Burner Power – 10.3 kw

Product Size mm (W x D x H) 900 x 525 x 120

Cutting Size mm (W x D x H) 860 x 485 x 55

### Dimensions of Built-in Hob with Electric Auto Ignition

Product dimensions: (w x d x h) 900 x 525 x 120 mm

Cutting dimensions: (w x d x h) 795 x 485 x 55 mm

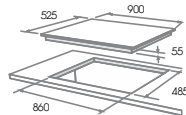

## CLASSIC FLEXI FB MFC SERIES



Full Brass Heavy Duty Multi-flame Control burners  
Flexi Hob-Top



## CLASSIC FLEXI FB MFC 4B 70 MT

Flexi Hob-Top - 4 Burner 70 cm  
Auto Ignition (Battery Operated)  
Round Metallic Knobs  
Cast iron pan support with Matt Enamelled  
**Full Brass Heavy Duty Multi-flame burners**  
**5 Years warranty on Glass, Burner & Valves**

### Full Brass Burners :

Heavy Duty Multi-Flame Control Burner – 4 kw x 1  
Heavy Duty Triple Ring Burner – 2.9 kw x 1  
Heavy Duty Double Ring Burners - 1.7 kw x 2  
Total Burner Power – 10.3 kw

Product Size mm (W x D x H) 700 x 525 x 120  
Cutting Size mm (W x D x H) 665 x 485 x 55

### Dimensions of Built-in Hob with Electric Auto Ignition

Product dimensions: (w x d x h) 700 x 525 x 120 mm  
Cutting dimensions: (w x d x h) 645 x 475 x 55 mm

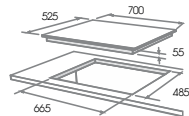

## CLASSIC FLEXI FB MFC SERIES



Full Brass Heavy Duty Multi-flame Control burners  
Flexi Hob-Top



## CLASSIC FLEXI FB MFC 4B 91 MT

Flexi Hob-Top - 4 Burner 90 cm  
Auto Ignition (Battery Operated)  
Round Metallic Knobs  
Cast iron pan support with Matt Enamelled  
**Full Brass Heavy Duty Multi-flame burners**  
**5 Years warranty on Glass, Burner & Valves**

### Full Brass Burners :

Heavy Duty Multi-Flame Control Burner – 4 kw x 1  
Heavy Duty Triple Ring Burner – 2.9 kw x 1  
Heavy Duty Double Ring Burners - 1.7 kw x 2  
Total Burner Power – 10.3 kw

Product Size mm (W x D x H) 900 x 525 x 120  
Cutting Size mm (W x D x H) 860 x 485 x 55

### Dimensions of Built-in Hob with Electric Auto Ignition

Product dimensions: (w x d x h) 900 x 525 x 120 mm  
Cutting dimensions: (w x d x h) 795 x 485 x 55 mm

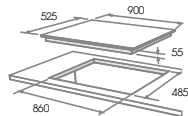



## CLASSIC FLEXI FB MFC SERIES



Full Brass Heavy Duty Multi-flame Control burners  
Flexi Hob-Top



### CLASSIC FLEXI FB MFC 5B 90 MT

Flexi Hob-Top - 5 Burner 90 cm  
Auto Ignition (Battery Operated)  
Round Metallic Knobs  
Cast iron pan support with Matt Enamelled  
**Full Brass Heavy Duty Multi-flame burners**  
**5 Years warranty on Glass, Burner & Valves**

#### Full Brass Burners :

Heavy Duty Multi-Flame Control Burner – 4 kw x 1  
Heavy Duty Triple Ring Burner – 2.9 kw x 1  
Heavy Duty Double Ring Burners - 1.7 kw x 3  
Total Burner Power – 12 kw

Product Size mm (W x D x H) 900 x 525 x 120

Cutting Size mm (W x D x H) 860 x 485 x 55

#### Dimensions of Built-in Hob with Electric Auto Ignition

Product dimensions: (w x d x h) 900 x 525 x 120 mm

Cutting dimensions: (w x d x h) 795 x 485 x 55 mm

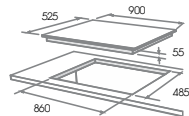

## CLASSIC FLEXI AB MFC SERIES



Multi-flame Control Advanced Brass burners  
Flexi Hob-Top



### CLASSIC FLEXI AB MFC 3B 60 MT

Flexi Hob-Top - 3 Burner 60 cm  
Auto Ignition (Battery Operated)  
Round Metallic Knobs  
Cast iron pan support with Matt Enamelled  
**Multi Flame Control Advanced Brass Burners**  
**5 Years warranty on Glass & Valves**

#### Brass Burners :

Heavy Duty Multi-Flame Control Burner – 4 kw x 1  
Heavy Duty Triple Ring Burner – 2.9 kw x 1  
Heavy Duty Double Ring Burner - 1.7 kw x 1  
Total Burner Power – 8.6 kw

Product Size mm (W x D x H) 600 x 525 x 120  
Cutting Size mm (W x D x H) 565 x 475 x 55

#### Dimensions of Built-in Hob with Electric Auto Ignition

Product dimensions: (w x d x h) 600 x 525 x 120 mm  
Cutting dimensions: (w x d x h) 564 x 485 x 55 mm

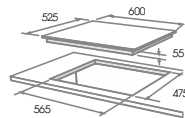
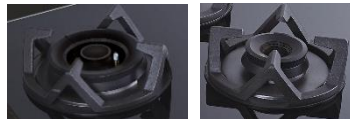

## CLASSIC FLEXI AB MFC SERIES



Multi-flame Control Advanced Brass burners  
Flexi Hob-Top



## CLASSIC FLEXI AB MFC 4B 60 MT

Flexi Hob-Top - 4 Burner 60 cm  
Auto Ignition (Battery Operated)  
Round Metallic Knobs  
Cast iron pan support with Matt Enamelled  
**Multi Flame Control Advanced Brass Burners**  
**5 Years warranty on Glass & Valves**

### Brass Burners :

Heavy Duty Multi-Flame Control Burner – 4 kw x 1  
Heavy Duty Triple Ring Burner – 2.9 kw x 1  
Heavy Duty Double Ring Burners - 1.7 kw x 2  
Total Burner Power – 10.3 kw

Product Size: mm (W x D x H) 600 x 520 x 120  
Cutting Size: mm (W x D x H) 565 x 475 x 55

### Dimensions of Built-in Hob with Electric Auto Ignition

Product dimensions: (w x d x h) 600 x 520 x 120 mm  
Cutting dimensions: (w x d x h) 560 x 485 x 55 mm

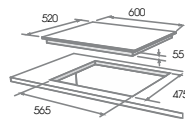
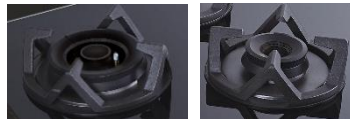

## CLASSIC FLEXI AB MFC SERIES



Multi-flame Control Advanced Brass burners  
Flexi Hob-Top



### CLASSIC FLEXI AB MFC 3B 70 MT

Flexi Hob-Top - 3 Burner 70 cm  
Auto Ignition (Battery Operated)  
Round Metallic Knobs  
Cast iron pan support with Matt Enamelled  
**Multi Flame Control Advanced Brass Burners**  
**5 Years warranty on Glass & Valves**

#### Brass Burners :

Heavy Duty Multi-Flame Control Burner – 4 kw x 1  
Heavy Duty Triple Ring Burner – 2.9 kw x 1  
Heavy Duty Double Ring Burner - 1.7 kw x 1  
Total Burner Power – 8.6 kw

Product Size: mm (W x D x H) 700 x 525 x 120  
Cutting Size: mm (W x D x H) 665 x 485 x 55

#### Dimensions of built-in hob with Electric Auto Ignition

Product dimensions: (w x d x h) 700 x 525 x 120 mm  
Cutting dimensions: (w x d x h) 645 x 475 x 55 mm

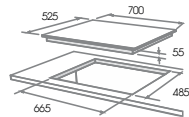
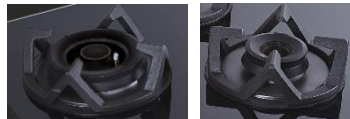

## CLASSIC FLEXI AB MFC SERIES



Multi-flame Control Advanced Brass burners  
Flexi Hob-Top



## CLASSIC FLEXI AB MFC 3B 75 MT

Flexi Hob-Top - 3 Burner 75 cm  
Auto Ignition (Battery Operated)  
Round Metallic Knobs  
Cast iron pan support with Matt Enamelled  
**Multi Flame Control Advanced Brass Burners**  
**5 Years warranty on Glass & Valves**

### Brass Burners :

Heavy Duty Multi-Flame Control Burner – 4 kw x 1  
Heavy Duty Triple Ring Burner – 2.9 kw x 1  
Heavy Duty Double Ring Burner - 1.7 kw x 1  
Total Burner Power – 8.6 kw

product Size: mm (W x D x H) 750 x 450 x 120  
Cutting Size: mm (W x D x H) 715 x 415 x 55

**Dimensions of Built-in Hob with Electric Auto Ignition**  
Product dimensions: (w x d x h) 750 x 450 x 120 mm  
Cutting dimensions: (w x d x h) 710 x 410 x 55 mm

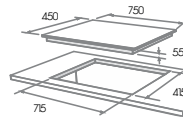
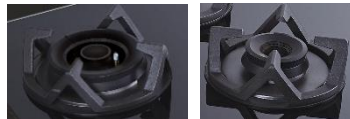

## CLASSIC FLEXI AB MFC SERIES



Multi-flame Control Advanced Brass burners  
Flexi Hob-Top



### CLASSIC FLEXI AB MFC 4B 70 MT

Flexi Hob-Top - 4 Burner 70 cm  
Auto Ignition (Battery Operated)  
Round Metallic Knobs  
Cast iron pan support with Matt Enamelled  
**Multi Flame Control Advanced Brass Burners**  
**5 Years warranty on Glass & Valves**

#### Brass Burners :

Heavy Duty Multi-Flame Control Burner – 4 kw x 1  
Heavy Duty Triple Ring Burner – 2.9 kw x 1  
Heavy Duty Double Ring Burners - 1.7 kw x 2  
Total Burner Power – 10.3 kw

Product dimensions: (w x d x h) 700 x 525 x 120 mm  
Cutting dimensions: (w x d x h) 665 x 485 x 55 mm

#### Dimensions of Built-in Hob with Electric Auto Ignition

Product dimensions: (w x d x h) 700 x 525 x 120 mm  
Cutting dimensions: (w x d x h) 645 x 475 x 55 mm

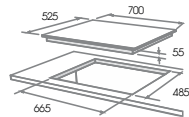
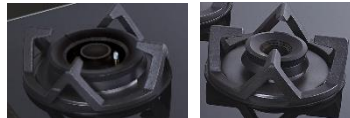

## CLASSIC FLEXI AB MFC SERIES



Multi-flame Control Advanced Brass burners  
Flexi Hob-Top



### CLASSIC FLEXI AB MFC 4B 91 MT

Flexi Hob-Top - 4 Burner 90 cm  
Auto Ignition (Battery Operated)  
Round Metallic Knobs  
Cast iron pan support with Matt Enamelled  
**Multi Flame Control Advanced Brass Burners**  
**5 Years warranty on Glass & Valves**

#### Brass Burners :

Heavy Duty Multi-Flame Control Burner – 4 kw x 1  
Heavy Duty Triple Ring Burner – 2.9 kw x 1  
Heavy Duty Double Ring Burners - 1.7 kw x 2  
Total Burner Power – 10.3 kw

Product dimensions: (w x d x h) 900 x 525 x 120 mm  
Cutting dimensions: (w x d x h) 860 x 485 x 55 mm

#### Dimensions of Built-in Hob with Electric Auto Ignition

Product dimensions: (w x d x h) 900 x 525 x 120 mm  
Cutting dimensions: (w x d x h) 795 x 485 x 55 mm

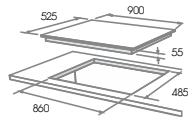
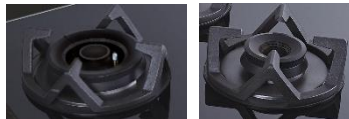

## CLASSIC FLEXI AB MFC SERIES



Multi-flame Control Advanced Brass burners  
Flexi Hob-Top



### CLASSIC FLEXI AB MFC 4B 75 MT

Flexi Hob-Top - 4 Burner 75 cm  
Auto Ignition (Battery Operated)  
Round Metallic Knobs  
Cast iron pan support with Matt Enamelled  
**Multi Flame Control Advanced Brass Burners**  
**5 Years warranty on Glass & Valves**

#### Brass Burners :

Heavy Duty Multi-Flame Control Burner – 4 kw x 1  
Heavy Duty Triple Ring Burner – 2.9 kw x 1  
Heavy Duty Double Ring Burners - 1.7 kw x 2  
Total Burner Power – 10.3 kw

Product dimensions: (w x d x h) 750 x 525 x 120 mm  
Cutting dimensions: (w x d x h) 710 x 485 x 55 mm

#### Dimensions of Built-in Hob with Electric Auto Ignition

Product dimensions: (w x d x h) 750 x 525 x 120 mm  
Cutting dimensions: (w x d x h) 705 x 475 x 55 mm

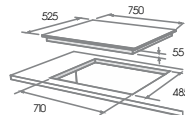
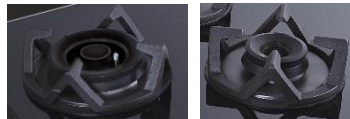



## CLASSIC FLEXI AB MFC SERIES



Multi-flame Control Advanced Brass burners  
Flexi Hob-Top



### CLASSIC FLEXI AB MFC 4B 90 MT

Flexi Hob-Top - 4 Burner 90 cm  
Auto Ignition (Battery Operated)  
Round Metallic Knobs  
Cast iron pan support with Matt Enamelled  
**Multi Flame Control Advanced Brass Burners**  
**5 Years warranty on Glass & Valves**

#### Brass Burners :

Heavy Duty Multi-Flame Control Burner – 4 kw x 1  
Heavy Duty Triple Ring Burner – 2.9 kw x 1  
Heavy Duty Double Ring Burners - 1.7 kw x 2  
Total Burner Power – 10.3 kw

Product dimensions: (w x d x h) 900 x 525 x 120 mm  
Cutting dimensions: (w x d x h) 860 x 485 x 55 mm

#### Dimensions of Built-in Hob with Electric Auto Ignition

Product dimensions: (w x d x h) 900 x 525 x 120 mm  
Cutting dimensions: (w x d x h) 795 x 485 x 55 mm

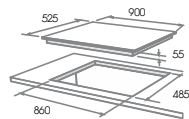
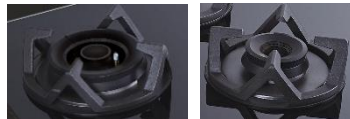

## CLASSIC FLEXI AB MFC SERIES



Multi-flame Control Advanced Brass burners  
Flexi Hob-Top



### CLASSIC FLEXI AB MFC 5B 90 MT

Flexi Hob-Top - 5 Burner 90 cm  
Auto Ignition (Battery Operated)  
Round Metallic Knobs  
Cast iron pan support with Matt Enamelled  
**Multi Flame Control Advanced Brass Burners**  
**5 Years warranty on Glass & Valves**

#### Brass Burners :

Heavy Duty Multi-Flame Control Burner – 4 kw x 1  
Heavy Duty Triple Ring Burner – 2.9 kw x 1  
Heavy Duty Double Ring Burners - 1.7 kw x 3  
Total Burner Power – 12 kw

Product dimensions: (w x d x h) 900 x 525 x 120 mm  
Cutting dimensions: (w x d x h) 860 x 485 x 55 mm

#### Dimensions of Built-in Hob with Electric Auto Ignition

Product dimensions: (w x d x h) 900 x 525 x 120 mm  
Cutting dimensions: (w x d x h) 795 x 485 x 55 mm

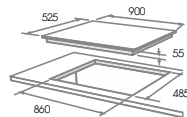
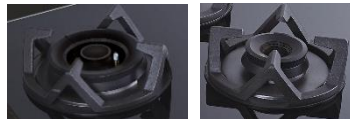

## CLASSIC FLEXI FB SERIES



Heavy Duty Full Brass burners  
Flexi Hob-Top



### CLASSIC FLEXI FB HCT 3B 75 DX

Flexi Hob-Top - 3 Burner 75 cm  
Auto Ignition (Battery Operated)  
Round Metallic Knobs  
Cast iron pan support with Matt Enamelled  
**Heavy Duty Full Brass Burners**  
**Double Enamelled Heavy Duty Cast Iron Grid**  
**5 Years warranty on Glass, Burner & Valves**

#### Full Brass Burners :

Heavy Duty Triple Ring Burners – 2.9 kw x 2  
Heavy Duty Double Ring Burner - 1.7 kw x 1  
Total Burner Power – 7.5 kw

Product Size mm (W x D x H)- 750 x 450 x 106  
Cutting Size mm (W x D x H)- 715 x 414 x 50

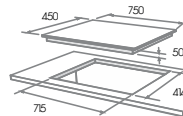

## CLASSIC FLEXI FB SERIES



Heavy Duty Full Brass burners  
Flexi Hob-Top



### CLASSIC FLEXI FB 4B 60 DX

Flexi Hob-Top - 4 Burner 60 cm  
Auto Ignition (Battery Operated)  
Round Metallic Knobs  
Cast iron pan support with Matt Enamelled  
**Heavy Duty Full Brass Burners**  
**Double Enamelled Heavy Duty Cast Iron Grid**  
**5 Years warranty on Glass, Burner & Valves**

#### Full Brass Burners :

Heavy Duty Triple Ring Burners – 2.9 kw x 2  
Heavy Duty Double Ring Burner - 1.7 kw x 2  
Total Burner Power – 9.2 kw

Product Size mm (W x D x H)- 600 x 520 x 120  
Cutting Size mm (W x D x H)- 565 x 475 x 55

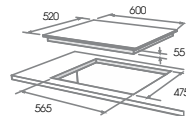

## CLASSIC FLEXI FB SERIES



Heavy Duty Full Brass burners  
Flexi Hob-Top



### CLASSIC FLEXI FB 4B 70 DX

Flexi Hob-Top - 4 Burner 70 cm  
Auto Ignition (Battery Operated)  
Round Metallic Knobs  
Cast iron pan support with Matt Enamelled  
**Heavy Duty Full Brass Burners**  
**Double Enamelled Heavy Duty Cast Iron Grid**  
**5 Years warranty on Glass, Burner & Valves**

#### Full Brass Burners :

Heavy Duty Triple Ring Burners – 2.9 kw x 2  
Heavy Duty Double Ring Burner - 1.7 kw x 2  
Total Burner Power – 9.2 kw

Product Size mm (W x D x H)- 700 x 520 x 106  
Cutting Size mm (W x D x H)- 660 x 480 x 50

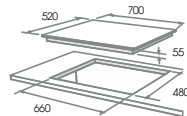
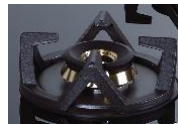

## CLASSIC FLEXI FB SERIES

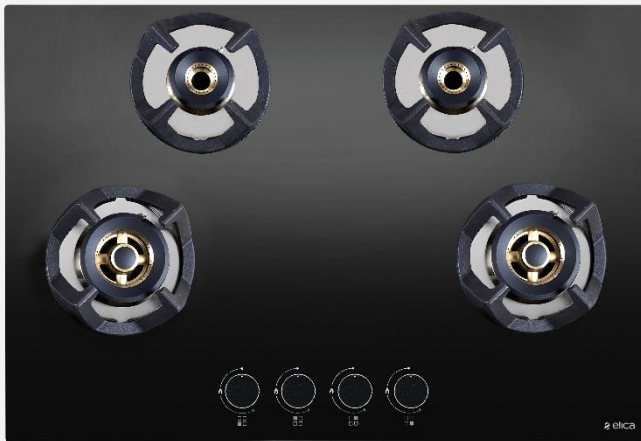

Heavy Duty Full Brass burners  
Flexi Hob-Top



### CLASSIC FLEXI FB 4B 75 DX

Flexi Hob-Top - 4 Burner 75 cm  
Auto Ignition (Battery Operated)  
Round Metallic Knobs  
Cast iron pan support with Matt Enamelled  
**Heavy Duty Full Brass Burners**  
**Double Enameled Heavy Duty Cast Iron Grid**  
**5 Years warranty on Glass, Burner & Valves**

#### Full Brass Burners :

Heavy Duty Triple Ring Burners – 2.9 kw x 2  
Heavy Duty Double Ring Burner - 1.7 kw x 2  
Total Burner Power – 9.2 kw

Product Size mm (W x D x H)- 750 x 525 x 120  
Cutting Size mm (W x D x H)- 710 x 485 x 55

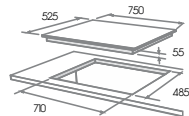

## CLASSIC FLEXI FB SERIES



Heavy Duty Full Brass burners  
Flexi Hob-Top



### CLASSIC FLEXI FB 4B 91 TX

Flexi Hob-Top - 4 Burner 90 cm  
Auto Ignition (Battery Operated)  
Round Metallic Knobs  
Cast iron pan support with Matt Enamelled  
**Heavy Duty Full Brass Burners**  
**Double Enamelled Heavy Duty Cast Iron Grid**  
**5 Years warranty on Glass, Burner & Valves**

#### Full Brass Burners :

Heavy Duty Triple Ring Burners – 2.9 kw x 2  
Heavy Duty Double Ring Burner - 1.7 kw x 2  
Total Burner Power – 9.2 kw

Product Size mm (W x D x H)- 900 x 525 x 120  
Cutting Size mm (W x D x H)- 860 x 485 x 55

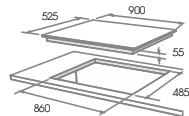

## CLASSIC FLEXI AB SERIES



Multi-Flame Control Advanced Brass burners  
Flexi Hob-Top



### CLASSIC FLEXI AB HCT 3B 75 DX

Flexi Hob-Top - 3 Burner 75 cm  
Auto Ignition (Battery Operated)  
Round Metallic Knobs  
Cast iron pan support with Matt Enamelled  
**Multi Flame Control Advanced Brass Burners**  
**5 Years warranty on Glass & Valves**

#### Brass Burners :

Heavy Duty Triple Ring Burners – 2.9 kw x 2  
Heavy Duty Double Ring Burner - 1.7 kw x 1  
Total Burner Power – 7.5 kw

Product Size: mm (W x D x H) 750 x 450 x 106

Cutting Size: mm (W x D x H) 715 x 414 x 50

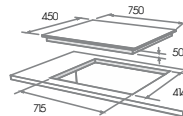



## CLASSIC FLEXI AB SERIES



### CLASSIC FLEXI AB HCT 3B 60

Flexi Hob-Top - 3 Burner 60 cm  
 Auto Ignition (Battery Operated)  
 Round Metallic Knobs  
 Cast iron pan support with Matt Enamelled  
**Multi Flame Control Advanced Brass Burners**  
**5 Years warranty on Glass & Valves**

#### Brass Burners :

Heavy Duty Triple Ring Burners – 2.9 kw x 1  
 Heavy Duty Double Ring Burner - 1.7 kw x 2  
 Total Burner Power – 6.3 kw

Product Size: mm (W x D x H) 600 x 520 x 106  
 Cutting Size: mm (W x D x H) 564 x 495 x 50

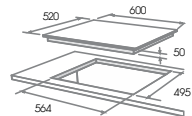

Multi-Flame Control Advanced Brass burners  
 Flexi Hob-Top



## CLASSIC FLEXI AB SERIES



### CLASSIC FLEXI AB HCT 4B 60

Flexi Hob-Top - 4 Burner 70 cm  
 Auto Ignition (Battery Operated)  
 Round Metallic Knobs  
 Cast iron pan support with Matt Enamelled  
**Multi Flame Control Advanced Brass Burners**  
**5 Years warranty on Glass & Valves**

#### Brass Burners :

Heavy Duty Triple Ring Burners – 2.9 kw x 1  
 Heavy Duty Double Ring Burner - 1.7 kw x 3  
 Total Burner Power – 8 kw

Product Size: mm (W x D x H) 600 x 520 x 106

Cutting Size: mm (W x D x H) 564 x 495 x 50

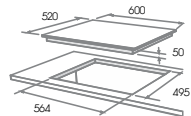

Multi-Flame Control Advanced Brass burners  
 Flexi Hob-Top



## CLASSIC FLEXI AB SERIES



Multi-Flame Control Advanced Brass burners  
Flexi Hob-Top



### CLASSIC FLEXI AB HCT 4B 70 DX

Flexi Hob-Top - 4 Burner 70 cm  
Auto Ignition (Battery Operated)  
Round Metallic Knobs  
Cast iron pan support with Matt Enamelled  
**Multi Flame Control Advanced Brass Burners**  
**5 Years warranty on Glass & Valves**

#### Brass Burners :

Heavy Duty Triple Ring Burners – 2.9 kw x 2  
Heavy Duty Double Ring Burner - 1.7 kw x 2  
Total Burner Power – 9.2 kw

Product Size: mm (W x D x H) 700 x 520 x 106  
Cutting Size: mm (W x D x H) 660 x 480 x 55

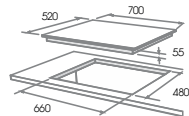

## CLASSIC SWIRL BURNERS SERIES



Multi-Flame Control Brass burners  
Flexi Hob-Top



### CLASSIC MFC 3B 70 SWIRL N

Flexi Hob-Top - 3 Burner 70 cm  
Auto Ignition (Battery Operated)  
Round Metallic Knobs  
Cast iron pan support with Matt Enamelled  
**Multi Flame Control Brass Burners**  
**5 Years warranty on Glass & Valves**

#### Brass Burners :

Multi-Flame Control Burner – 4 kw x 1  
Heavy Duty 86 mm Swirl Burner – 2.2 kw x 1  
Heavy Duty 70 mm Swirl Burner – 1.5 kw x 1  
Total Burner Power – 7.7 kw

Product Size mm (W x D x H) 700 x 525 x 120  
Cutting Size mm (W x D x H) 645 x 475 x 55

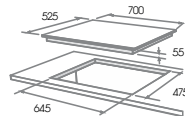

## CLASSIC SWIRL BURNERS SERIES



Multi-Flame Control Brass burners  
Flexi Hob-Top



### CLASSIC MFC 4B 70 SWIRL N

Flexi Hob-Top - 4 Burner 70 cm  
Auto Ignition (Battery Operated)  
Round Metallic Knobs  
Cast iron pan support with Matt Enamelled  
**Multi Flame Control Brass Burners**  
**5 Years warranty on Glass & Valves**

#### Brass Burners :

Multi-Flame Control Burner – 4 kw x 1  
Heavy Duty 86 mm Swirl Burner – 2.2 kw x 2  
Heavy Duty 70 mm Swirl Burner – 1.5 kw x 1  
Total Burner Power – 9.9 kw

Product Size mm (W x D x H) 700 x 525 x 120  
Cutting Size mm (W x D x H) 645 x 475 x 55

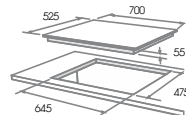



MULTI-FLAME CONTROL  
DOUBLE DRIP TRAY

EASY TO CLEAN  
AND MAINTAIN,  
NOW TURN YOUR  
KITCHEN INTO  
A STYLISH  
NEW HANGOUT.





## DT SWIRL BURNERS SERIES



Multi-Flame Control Brass burners  
Flexi Hob-Top



### DT FLEXI MFC 3B 60 SWIRL

Flexi Hob-Top - 3 Burner 60 cm  
Auto Ignition (Battery Operated)  
Enameled Grids, Round Metallic Knobs  
**Multi Flame Control Brass Burners**  
**5 Years warranty on Glass & Valves**

#### Brass Burners :

Multi-Flame Control Burner – 4 kw x 1  
Heavy Duty 86 mm Swirl Burner – 2.2 kw x 1  
Heavy Duty 70 mm Swirl Burner – 1.5 kw x 1  
Total Burner Power – 7.7 kw

Product Size mm (W x D x H) 600 x 520 x 120  
Cutting Size mm (W x D x H)- 565 x 475 x 55

#### Dimensions of Built-in Hob with Electric Auto Ignition

Product dimensions: (w x d x h) 600 x 525 x 120 mm  
Cutting dimensions: (w x d x h) 564 x 485 x 55 mm

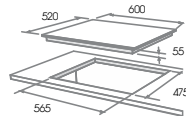



## DT SWIRL BURNERS SERIES



Multi-Flame Control Brass burners  
Flexi Hob-Top



### DT FLEXI MFC 3B 70 SWIRL

Flexi Hob-Top - 3 Burner 70 cm  
Auto Ignition (Battery Operated)  
Enameled Grids, Round Metallic Knobs  
**Multi Flame Control Brass Burners**  
**5 Years warranty on Glass & Valves**

#### Brass Burners :

Multi-Flame Control Burner – 4 kw x 1  
Heavy Duty 86 mm Swirl Burner – 2.2 kw x 1  
Heavy Duty 70 mm Swirl Burner– 1.5 kw x 1  
Total Burner Power – 7.7 kw

Product Size mm (W x D x H) 700 x 525 x 120  
Cutting Size mm (W x D x H) 665 x 485 x 55

#### Dimensions of Built-in Hob with Electric Auto Ignition

Product dimensions: (w x d x h) 700 x 525 x 120 mm  
Cutting dimensions: (w x d x h) 645 x 475 x 55 mm

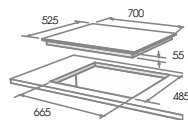

## DT SWIRL BURNERS SERIES



Multi-Flame Control Brass burners  
Flexi Hob-Top



### DT FLEXI MFC 4B 60 SWIRL

Flexi Hob-Top - 4 Burner 60 cm  
Auto Ignition (Battery Operated)  
Enameled Grids, Round Metallic Knobs  
**Multi Flame Control Brass Burners**  
**5 Years warranty on Glass & Valves**

#### Brass Burners :

Multi-Flame Control Burner – 4 kw x 1  
Heavy Duty 86 mm Swirl Burner – 2.2 kw x 2  
Heavy Duty 70 mm Swirl Burner – 1.5 kw x 1  
Total Burner Power – 9.9 kw

Product Size mm (W x D x H) 600 x 520 x 120  
Cutting Size mm (W x D x H)- 565 x 475 x 55

#### Dimensions of Built-in Hob with Electric Auto Ignition

Product dimensions: (w x d x h) 600 x 520 x 120 mm  
Cutting dimensions: (w x d x h) 560 x 485 x 55 mm

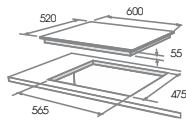

## DT SWIRL BURNERS SERIES



Multi-Flame Control Brass burners  
Flexi Hob-Top



### DT FLEXI MFC 3B 70 DX SWIRL

Flexi Hob-Top - 3 Burner 70 cm  
Auto Ignition (Battery Operated)  
Enameled Grids  
Round Metallic Knobs  
**Multi Flame Control Brass Burners**  
**5 Years warranty on Glass & Valves**

#### Brass Burners :

Multi-Flame Control Burner – 4 kw x 2  
Heavy Duty 86 mm Swirl Burner – 2.2 kw x 1  
Total Burner Power – 10.2 kw

Product Size mm (W x D x H) 700 x 525 x 120  
Cutting Size mm (W x D x H) 665 x 485 x 55

#### Dimensions of Built-in Hob with Electric Auto Ignition

Product dimensions: (w x d x h) 700 x 525 x 120 mm  
Cutting dimensions: (w x d x h) 645 x 475 x 55 mm

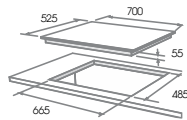

## DT SWIRL BURNERS SERIES



Multi-Flame Control Brass burners  
Flexi Hob-Top



### DT FLEXI MFC 4B 70 DX SWIRL

Flexi Hob-Top - 4 Burner 70 cm  
Auto Ignition (Battery Operated)  
Enameled Grids  
Round Metallic Knobs  
**Multi Flame Control Brass Burners**  
**5 Years warranty on Glass & Valves**

#### Brass Burners :

Multi-Flame Control Burner – 4 kw x 2  
Heavy Duty 86 mm Swirl Burner – 2.2 kw x 1  
Heavy Duty 70 mm Swirl Burner – 1.5 kw x 1

Product Size mm (W x D x H) 700 x 525 x 120  
Cutting Size mm (W x D x H) 665 x 485 x 55

#### Dimensions of Built-in Hob with Electric Auto Ignition

Product dimensions: (w x d x h) 700 x 525 x 120 mm  
Cutting dimensions: (w x d x h) 645 x 475 x 55 mm

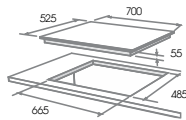

## DT SWIRL BURNERS SERIES



Multi-Flame Control Brass burners  
Flexi Hob-Top



### DT FLEXI MFC 4B 70 SWIRL

Flexi Hob-Top - 4 Burner 70 cm  
Auto Ignition (Battery Operated)  
Enameled Grids, Round Metallic Knobs  
**Multi Flame Control Brass Burners**  
**5 Years warranty on Glass & Valves**

#### Brass Burners :

Multi-Flame Control Burner – 4 kw x 1  
Heavy Duty 86 mm Swirl Burner – 2.2 kw x 2  
Heavy Duty 70 mm Swirl Burner– 1.5 kw x 1  
Total Burner Power – 9.9 kw

Product dimensions: (w x d x h) 700 x 525 x 120 mm  
Cutting dimensions: (w x d x h) 665 x 485 x 55 mm

#### Dimensions of Built-in Hob with Electric Auto Ignition

Product dimensions: (w x d x h) 700 x 525 x 120 mm  
Cutting dimensions: (w x d x h) 645 x 475 x 55 mm

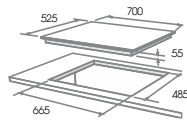

## DT SWIRL BURNERS SERIES



Multi-Flame Control Brass burners  
Flexi Hob-Top



### DT FLEXI MFC 4B 91 SWIRL

Flexi Hob-Top - 4 Burner 90 cm  
Auto Ignition (Battery Operated)  
Enameled Grids, Round Metallic Knobs  
**Multi Flame Control Brass Burners**  
**5 Years warranty on Glass & Valves**

#### Brass Burners :

Multi-Flame Control Burner – 4 kw x 1  
Heavy Duty 86 mm Swirl Burner – 2.2 kw x 2  
Heavy Duty 70 mm Swirl Burner – 1.5 kw x 1  
Total Burner Power – 9.9 kw

Product dimensions: (w x d x h) 900 x 525 x 120 mm  
Cutting dimensions: (w x d x h) 860 x 485 x 55 mm

#### Dimensions of Built-in Hob with Electric Auto Ignition

Product dimensions: (w x d x h) 900 x 525 x 120 mm  
Cutting dimensions: (w x d x h) 795 x 485 x 55 mm

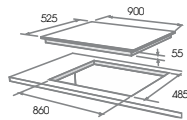

## DT SWIRL BURNERS SERIES



Multi-Flame Control Brass burners  
Flexi Hob-Top



### DT FLEXI MFC 5B 90 SWIRL

Flexi Hob-Top - 5 Burner 90 cm  
Auto Ignition (Battery Operated)  
Enameled Grids, Round Metallic Knobs  
**Multi Flame Control Brass Burners**  
**5 Years warranty on Glass & Valves**

#### Brass Burners :

Multi-Flame Control Burner – 4 kw x 1  
Heavy Duty 86 mm Swirl Burner – 2.2 kw x 3  
Heavy Duty 70 mm Swirl Burner – 1.5 kw x 1  
Total Burner Power – 12.1 kw

Product Size mm (W x D x H) 900 x 525 x 120  
Cutting Size mm (W x D x H) 860 x 485 x 55

#### Dimensions of Built-in Hob with Electric Auto Ignition

Product dimensions: (w x d x h) 900 x 525 x 120 mm  
Cutting dimensions: (w x d x h) 795 x 485 x 55 mm

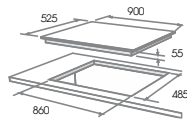

## DT FLEXI FB BURNERS SERIES



Full Brass Heavy Duty Multi-flame Control burners  
Flexi Hob-Top



### DT FLEXI FB MFC 4B 60 SWIRL

Flexi Hob-Top - 4 Burner 60 cm  
Auto Ignition (Battery Operated)  
Enamelled Grids, Round Metallic Knobs  
**Full Brass Heavy Duty Multi Flame Burners**  
**5 Years warranty on Glass & Valves**

#### Full Brass Burners :

Heavy Duty Multi-Flame Control Burner – 4 kw x 1  
Heavy Duty 86 mm Swirl Burner – 2.2 kw x 2  
Heavy Duty 70 mm Swirl Burner– 1.5 kw x 1  
Total Burner Power – 9.9 kw

Product Size mm (W x D x H) 600 x 520 x 120  
Cutting Size mm (W x D x H) 565 x 475 x 55

#### Dimensions of Built-in Hob with Electric Auto Ignition

Product dimensions: (w x d x h) 600 x 525 x 120 mm  
Cutting dimensions: (w x d x h) 560 x 485 x 55 mm

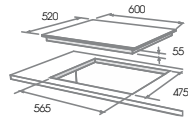



## DT FLEXI FB BURNERS SERIES



Full Brass Heavy Duty Multi-flame Control burners  
Built-in Hob



### DT FB MFC 4B 65 SWIRL

Built-in Hob - 4 Burner 65 cm  
Auto Ignition (Battery Operated)  
Enamelled Grids, Round Metallic Knobs  
**Full Brass Heavy Duty Multi Flame Burners**  
**5 Years warranty on Glass & Valves**

#### Full Brass Burners :

Heavy Duty Multi-Flame Control Burner – 4 kw x 1  
Heavy Duty 86 mm Swirl Burner – 2.2 kw x 2  
Heavy Duty 70 mm Swirl Burner– 1.5 kw x 1  
Total Burner Power – 9.9 kw

Product Size mm (W x D x H) 650 x 525 x 120  
Cutting Size mm (W x D x H) 564 x 485 x 55

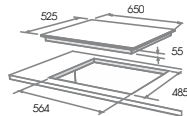
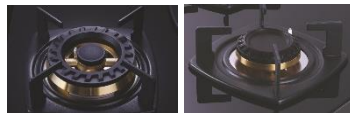

## DT FLEXI FB BURNERS SERIES



Full Brass Heavy Duty Multi-flame Control burners  
Flexi Hob-Top



### DT FLEXI FB MFC 3B 70 SWIRL

Flexi Hob-Top - 3 Burner 70 cm  
Auto Ignition (Battery Operated)  
Enamelled Grids, Round Metallic Knobs  
**Full Brass Heavy Duty Multi Flame Burners**  
**5 Years warranty on Glass & Valves**

#### Full Brass Burners :

Heavy Duty Multi-Flame Control Burner – 4 kw x 1  
Heavy Duty 86 mm Swirl Burner – 2.2 kw x 1  
Heavy Duty 70 mm Swirl Burner– 1.5 kw x 1  
Total Burner Power – 7.7 kw

product Size mm (W x D x H) 700 x 525 x 120  
Cutting Size mm (W x D x H) 665 x 485 x 55

#### Dimensions of Built-in Hob with Electric Auto Ignition

Product dimensions: (w x d x h) 700 x 525 x 120 mm  
Cutting dimensions: (w x d x h) 645 x 475 x 55 mm

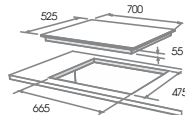

## DT FLEXI FB BURNERS SERIES



Full Brass Heavy Duty Multi-flame Control burners  
Flexi Hob-Top



### DT FLEXI FB MFC 4B 70 SWIRL

Flexi Hob-Top - 4 Burner 70 cm  
Auto Ignition (Battery Operated)  
Enamelled Grids , Round Metallic Knobs  
**Full Brass Heavy Duty Multi Flame Burners**  
**5 Years warranty on Glass & Valves**

#### Full Brass Burners :

Heavy Duty Multi-Flame Control Burner – 4 kw x 1  
Heavy Duty 86 mm Swirl Burner – 2.2 kw x 2  
Heavy Duty 70 mm Swirl Burner– 1.5 kw x 1  
Total Burner Power – 9.9 kw

Product Size mm (W x D x H) 700 x 525 x 120  
Cutting Size mm (W x D x H) 665 x 485 x 55

#### Dimensions of Built-in Hob with Electric Auto Ignition

Product dimensions: (w x d x h) 700 x 525 x 120 mm  
Cutting dimensions: (w x d x h) 645 x 475 x 55 mm

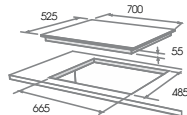

## DT FLEXI FB BURNERS SERIES



Full Brass Heavy Duty Multi-flame Control burners  
Flexi Hob-Top



### DT FLEXI FB MFC 4B 91 SWIRL

Flexi Hob-Top - 4 Burner 90 cm  
Auto Ignition (Battery Operated)  
Enamelled Grids, Round Metallic Knobs  
**Full Brass Heavy Duty Multi Flame Burners**  
**5 Years warranty on Glass & Valves**

#### Full Brass Burners :

Heavy Duty Multi-Flame Control Burner – 4 kw x 1  
Heavy Duty 86 mm Swirl Burner – 2.2 kw x 2  
Heavy Duty 70 mm Swirl Burner– 1.5 kw x 1  
Total Burner Power – 9.9 kw

Product Size mm (W x D x H) 900 x 525 x 120  
Cutting Size mm (W x D x H) 860 x 485 x 55

#### Dimensions of Built-in Hob with Electric Auto Ignition

Product dimensions: (w x d x h) 900 x 525 x 120 mm  
Cutting dimensions: (w x d x h) 795 x 485 x 55 mm

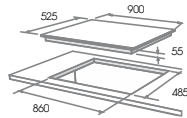
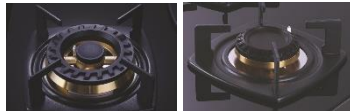



MULTI-FLAME CONTROL  
SQUARE GRID SERIES

WHAT  
GREAT KITCHENS  
DESERVE.





## FLEXI FB HCT SERIES



### FLEXI FB HCT 375 DX

Flexi Hob-Top - 3 Burner 75 cm  
 Auto Ignition (Battery Operated)  
 Cast Iron Grids  
 Round Metallic Knobs  
**Full brass heavy duty multi-ring burners**  
**5 Years warranty on Glass, Burners & Valves**

**Full Brass Burners :**  
 Heavy Duty Triple Ring Burner – 2.9 kw x 2  
 Heavy Duty Double Ring Burner - 1.7 kw x 1  
 Total Burner Power – 7.5 kw

Product Size mm (W x D x H) 750 x 450 x 106  
 Cutting Size mm (W x D x H) 715 x 414 x 50

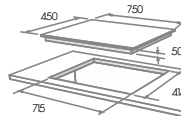

Full Brass Heavy Duty Multi-flame-ring burners  
 Flexi Hob-Top



## FLEXI FB HCT SERIES



### FLEXI FB HCT 491 DX

Flexi Hob-Top - 4 Burner 90 cm  
 Auto Ignition (Battery Operated)  
 Cast Iron Grids  
 Round Metallic Knobs  
**Full brass heavy duty multi-ring burners**  
**5 Years warranty on Glass, Burners & Valves**

**Full Brass Burners :**  
 Heavy Duty Triple Ring Burner – 2.9 kw x 2  
 Heavy Duty Double Ring Burner - 1.7 kw x 2  
 Total Burner Power – 9.2 kw

Product Size mm (W x D x H) 900 x 525 x 120  
 Cutting Size mm (W x D x H) 860 x 485 x 55

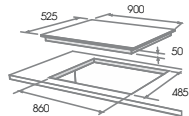

Full Brass Heavy Duty Multi-flame-ring burners  
 Flexi Hob-Top





## FLEXI FB HCT SERIES

### FLEXI FB HCT 475 DX

Flexi Hob-Top - 4 Burner 75 cm  
 Auto Ignition (Battery Operated)  
 Cast Iron Grids  
 Round Metallic Knobs  
**Full brass heavy duty multi-ring burners**  
**5 Years warranty on Glass, Burners & Valves**

**Full Brass Burners :**  
 Heavy Duty Triple Ring Burner – 2.9 kw x 2  
 Heavy Duty Double Ring Burner - 1.7 kw x 2  
 Total Burner Power – 9.2 kw

Product Size mm (W x D x H) 750 x 525 x 120  
 Cutting Size mm (W x D x H) 710 x 485 x 55

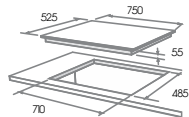

Full Brass Heavy Duty Multi-flame-ring burners  
 Flexi Hob-Top



## FLEXI FB HCT SERIES



### FLEXI FB HCT 470 DX

Flexi Hob-Top - 4 Burner 70 cm  
Auto Ignition (Battery Operated)  
Cast Iron Grids  
Round Metallic Knobs

**Full brass heavy duty multi-ring burners**  
**5 Years warranty on Glass, Burners & Valves**

#### Full Brass Burners :

Heavy Duty Triple Ring Burner – 2.9 kw x 2  
Heavy Duty Double Ring Burner - 1.7 kw x 2  
Total Burner Power – 9.2 kw

Product Size mm (W x D x H) 700 x 525 x 106  
Cutting Size mm (W x D x H) 660 x 480 x 50

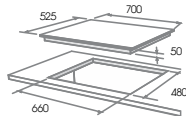

Full Brass Heavy Duty Multi-flame-ring burners  
Flexi Hob-Top



## FLEXI AB HCT SERIES



### FLEXI AB HCT 360

Flexi Hob-Top - 3 Burner 60 cm  
 Auto Ignition (Battery Operated)  
 Cast Iron Grids  
 Round Metallic Knobs  
**Advanced Brass Burners**  
**5 Years warranty on Glass & Valves**

**Full Brass Burners :**  
 Heavy Duty Triple Ring Burner – 2.9 kw x 1  
 Heavy Duty Double Ring Burner - 1.7 kw x 2  
 Total Burner Power – 6.3 kw

Product Size mm (W x D x H) 600 x 520 x 106  
 Cutting Size mm (W x D x H) 564 x 495 x 50

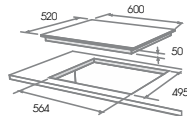
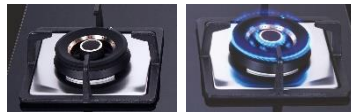

Advanced Brass Burners  
 Flexi Hob-Top



## FLEXI AB HCT SERIES



### FLEXI AB HCT 375 DX

Flexi Hob-Top - 3 Burner 75 cm  
 Auto Ignition (Battery Operated)  
 Cast Iron Grids  
 Round Metallic Knobs  
**Advanced Brass Burners**  
**5 Years warranty on Glass & Valves**

**Full Brass Burners :**  
 Heavy Duty Triple Ring Burner – 2.9 kw x 2  
 Heavy Duty Double Ring Burner - 1.7 kw x 1  
 Total Burner Power – 7.5 kw

Product Size mm (W x D x H) 750 x 450 x 106  
 Cutting Size mm (W x D x H) 715 x 414 x 50

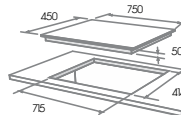
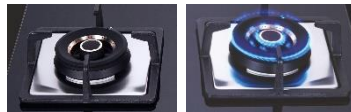

Advanced Brass Burners  
 Flexi Hob-Top



## FLEXI AB HCT SERIES



### FLEXI AB HCT 460

Flexi Hob-Top - 4 Burner 60 cm  
 Auto Ignition (Battery Operated)  
 Cast Iron Grids  
 Round Metallic Knobs  
**Advanced Brass Burners**  
**5 Years warranty on Glass & Valves**

**Full Brass Burners :**  
 Heavy Duty Triple Ring Burner – 2.9 kw x 1  
 Heavy Duty Double Ring Burner - 1.7 kw x 3  
 Total Burner Power – 8 kw

Product Size mm (W x D x H) 600 x 520 x 106  
 Cutting Size mm (W x D x H) 564 x 495 x 50

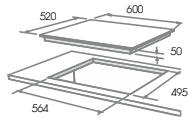
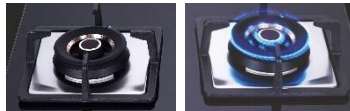

Advanced Brass Burners  
 Flexi Hob-Top



## FLEXI AB HCT SERIES



### FLEXI AB HCT 470 DX

Flexi Hob-Top - 4 Burner 70 cm  
 Auto Ignition (Battery Operated)  
 Cast Iron Grids  
 Round Metallic Knobs  
**Advanced Brass Burners**  
**5 Years warranty on Glass & Valves**

**Full Brass Burners :**  
 Heavy Duty Triple Ring Burner – 2.9 kw x 2  
 Heavy Duty Double Ring Burner - 1.7 kw x 2  
 Total Burner Power – 9.2 kw

Product Size mm (W x D x H) 700 x 520 x 106  
 Cutting Size mm (W x D x H) 660 x 480 x 50

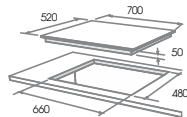
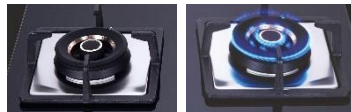

Advanced Brass Burners  
 Flexi Hob-Top



## FLEXI AB HCT SERIES



### FLEXI AB HCT 491 DX

Flexi Hob-Top - 4 Burner 90 cm  
 Auto Ignition (Battery Operated)  
 Cast Iron Grids  
 Round Metallic Knobs  
**Advanced Brass Burners**  
**5 Years warranty on Glass & Valves**

#### Full Brass Burners :

Heavy Duty Triple Ring Burner – 2.9 kw x 2  
 Heavy Duty Double Ring Burner - 1.7 kw x 2  
 Total Burner Power – 9.2 kw

Product Size mm (W x D x H) 900 x 525x 120  
 Cutting Size mm (W x D x H) 860 x 485 x 55

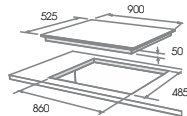
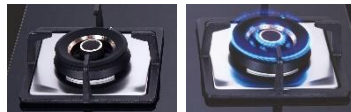

Advanced Brass Burners  
 Flexi Hob-Top



## FLEXI SWIRL SERIES



### FLEXI SWIRL 3B 75 MT NX

Flexi Hob-Top - 3 Burner 75 cm  
 Auto Ignition (Battery Operated)  
 Cast Iron Grids  
 Round Knobs BK  
**Multi-Ring Swirl Brass Burners**  
**5 Years warranty on Glass & Valves**

#### Brass Burners :

Heavy Duty Triple Ring Burner – 2.9 kw x 1  
 Heavy Duty 86 mm Swirl Burner – 2.2 kw x 1  
 Heavy Duty 70 mm Swirl Burner - 1.5 kw x 1  
 Total Burner Power – 6.6 kw

Product Size mm (W x D x H)- 750 x 450 x 106  
 Cutting Size mm (W x D x H)- 715 x 414 x 50

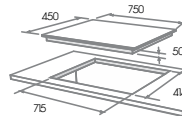
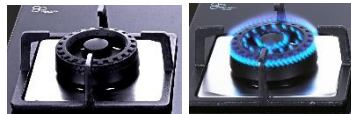

Multi-Ring Swirl Brass Burners  
 Flexi Hob-Top





## FLEXI SWIRL SERIES



### FLEXI SWIRL 4B 60 PLUS MT NX

Flexi Hob-Top - 4 Burner 60 cm  
 Auto Ignition (Battery Operated)  
 Cast Iron Grids  
 Round Knobs BK  
**Multi-Ring Swirl Brass Burners**  
**5 Years warranty on Glass & Valves**

#### Brass Burners :

Heavy Duty Triple Ring Burner – 2.9 kw x 1  
 Heavy Duty 86 mm Swirl Burner – 2.2 kw x 1  
 Heavy Duty 70 mm Swirl Burner - 1.5 kw x 2  
 Total Burner Power – 8.1 kw

Product Size mm (W x D x H) 600 x 520 x 106  
 Cutting Size mm (W x D x H) 564 x 495 x 50

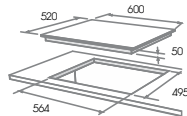
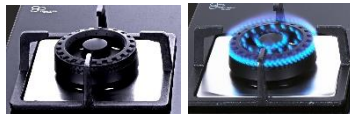

Multi-Ring Swirl Brass Burners  
 Flexi Hob-Top



## FLEXI SWIRL SERIES

### FLEXI SWIRL 4B 70 MT NX

Flexi Hob-Top - 4 Burner 70 cm  
 Auto Ignition (Battery Operated)  
 Cast Iron Grids  
 Round Knobs BK  
**Multi-Ring Swirl Brass Burners**  
**5 Years warranty on Glass & Valves**

#### Brass Burners :

Heavy Duty Triple Ring Burner – 2.9 kw x 1  
 Heavy Duty 86 mm Swirl Burner – 2.2 kw x 1  
 Heavy Duty 70 mm Swirl Burner - 1.5 kw x 2  
 Total Burner Power – 8.1 kw

Product Size mm (W x D x H) 700 x 520 x 106  
 Cutting Size mm (W x D x H) 660 x 480 x 50

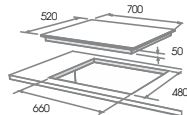
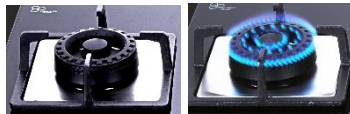

Multi-Ring Swirl Brass Burners  
 Flexi Hob-Top



## FLEXI SWIRL SERIES



### FLEXI SWIRL 4B 91 MT NX

Flexi Hob-Top - 4 Burner 90 cm  
 Auto Ignition (Battery Operated)  
 Cast Iron Grids  
 Round Knobs BK  
**Multi-Ring Swirl Brass Burners**  
**5 Years warranty on Glass & Valves**

#### Brass Burners :

Heavy Duty Triple Ring Burner – 2.9 kw x 1  
 Heavy Duty 86 mm Swirl Burner – 2.2 kw x 2  
 Heavy Duty 70 mm Swirl Burner - 1.5 kw x 1  
 Total Burner Power – 8.8 kw

Product Size mm (W x D x H) 900 x 520 x 120  
 Cutting Size mm (W x D x H) 860 x 485 x 55

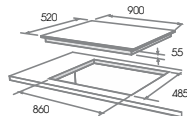
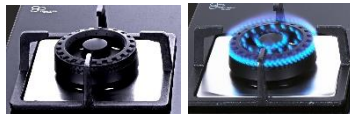

Multi-Ring Swirl Brass Burners  
 Flexi Hob-Top



## FLEXI MFC FB SWIRL SERIES



### FLEXI MFC FB 370 SWIRL

Flexi Hob-Top - 3 Burner 70 cm  
Auto Ignition (Battery Operated)

Cast Iron Grids

Round Metallic Knobs

**Full brass heavy duty multi-flame burners**

**5 Years warranty on Glass & Valves**

#### Full Brass Burners :

Heavy Duty Multi-Flame Control Burner – 4 kw x 1

Heavy Duty 86 mm Swirl Burner – 2.2 kw x 1

Heavy Duty 70 mm Swirl Burner - 1.5 kw x 1

Total Burner Power – 7.7 kw

Product Size mm (W x D x H) 700 x 525 x 120

Cutting Size mm (W x D x H) 665 x 485 x 55

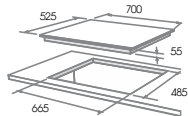

Full Brass Heavy Duty Multi-flame burners  
Flexi Hob-Top



## FLEXI MFC FB SWIRL SERIES

### FLEXI MFC FB 470 SWIRL

Flexi Hob-Top - 4 Burner 70 cm

Auto Ignition (Battery Operated)

Cast Iron Grids

Round Metallic Knobs

**Full brass heavy duty multi-flame burners**

**5 Years warranty on Glass & Valves**

#### Full Brass Burners :

Heavy Duty Multi-Flame Control Burner – 4 kw x 1

Heavy Duty 86 mm Swirl Burner – 2.2 kw x 2

Heavy Duty 70 mm Swirl Burner - 1.5 kw x 1

Total Burner Power – 9.9 kw

Product Size mm (W x D x H) 700 x 525 x 120

Cutting Size mm (W x D x H) 665 x 485 x 55

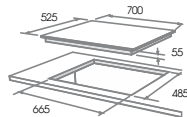
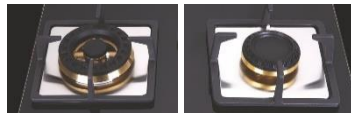

Full Brass Heavy Duty Multi-flame burners  
Flexi Hob-Top



## FLEXI MFC FB SWIRL SERIES

### FLEXI MFC FB 491 SWIRL

Flexi Hob-Top - 4 Burner 90 cm

Auto Ignition (Battery Operated)

Cast Iron Grids

Round Metallic Knobs

**Full brass heavy duty multi-flame burners**

**5 Years warranty on Glass & Valves**

#### Full Brass Burners :

Heavy Duty Multi-Flame Control Burner – 4 kw x 1

Heavy Duty 86 mm Swirl Burner – 2.2 kw x 3

Total Burner Power – 10.6 kw

Product Size mm (W x D x H) 900 x 525 x 120

Cutting Size mm (W x D x H) 860 x 485 x 55

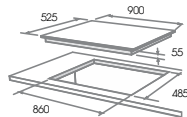
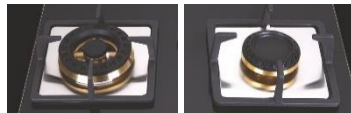

Full Brass Heavy Duty Multi-flame burners  
Flexi Hob-Top



## FLEXI MFC AB SERIES



### FLEXI MFC AB 370 MT

Flexi Hob-Top - 3 Burner 70 cm  
 Auto Ignition (Battery Operated)  
 Cast Iron Grids  
 Round Metallic Knobs  
**Multi-flame Control Advance Brass burners**  
**5 Years warranty on Glass & Valves**

#### Full Brass Burners :

Heavy Duty Multi-Flame Control Burner – 4 kw x 1  
 Heavy Duty Triple Ring Burner – 2.9 kw x 1  
 Heavy Duty Double Ring Burner - 1.7 kw x 1  
 Total Burner Power – 8.6 kw

Product Size mm (W x D x H) 700 x 525 x 120  
 Cutting Size mm (W x D x H) 665 x 485 x 55

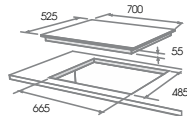

Multi-flame Control Advance Brass burners  
 Flexi Hob-Top



## FLEXI MFC AB SERIES



### FLEXI MFC AB 470 MT

Flexi Hob-Top - 4 Burner 70 cm  
 Auto Ignition (Battery Operated)  
 Cast Iron Grids  
 Round Metallic Knobs  
**Multi-flame Control Advance Brass burners**  
**5 Years warranty on Glass & Valves**

#### Full Brass Burners :

Heavy Duty Multi-Flame Control Burner – 4 kw x 1  
 Heavy Duty Triple Ring Burner – 2.9 kw x 1  
 Heavy Duty Double Ring Burner - 1.7 kw x 2  
 Total Burner Power – 10.3 kw

Product Size mm (W x D x H) 700 x 525 x 120  
 Cutting Size mm (W x D x H) 665 x 485 x 55

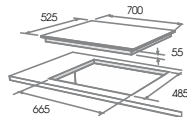

Multi-flame Control Advance Brass burners  
 Flexi Hob-Top





## FLEXI MFC AB SERIES



### FLEXI MFC AB 491 MT

Flexi Hob-Top - 4 Burner 90 cm  
 Auto Ignition (Battery Operated)  
 Cast Iron Grids  
 Round Metallic Knobs  
**Multi-flame Control Advance Brass burners**  
**5 Years warranty on Glass & Valves**

#### Full Brass Burners :

Heavy Duty Multi-Flame Control Burner – 4 kw x 1  
 Heavy Duty Triple Ring Burner – 2.9 kw x 1  
 Heavy Duty Double Ring Burner - 1.7 kw x 2  
 Total Burner Power – 10.3 kw

Product Size mm (W x D x H) 900 x 525 x 120  
 Cutting Size mm (W x D x H) 860 x 485 x 55

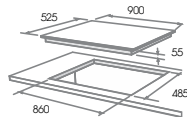

Multi-flame Control Advance Brass burners  
 Flexi Hob-Top



## FLEXI LOTUS SERIES



### FLEXI HCT 375 DX LOTUS BK

Flexi Hob-Top - 3 Burner 75 cm  
 Cast Iron Grids  
 Round Knobs BK  
**Enameled Coated Burners**  
**5 Years warranty on Glass & Valves**

**Lotus Burners :**  
 Heavy Triple Ring Burner – 2.5 kw x 2  
 Heavy Double Ring Burner - 1.7 kw x 1  
 Total Burner Power – 6.6 kw

Product Size mm (WxDxH) 750 x 450 x 106  
 Cutting Size mm (WxDxH) 715 x 414 x 50

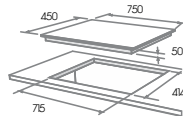

Enameled Coated Burners  
 Flexi Hob-Top



## FLEXI LOTUS SERIES



### FLEXI HCT 470 DX LOTUS BK

Flexi Hob-Top - 3 Burner 75 cm

Cast Iron Grids

Round Knobs BK

**Enameled Coated Burners**

**5 Years warranty on Glass & Valves**

#### **Lotus Burners :**

Heavy Triple Ring Burner – 2.5 kw x 2

Heavy Double Ring Burner - 1.7 kw x 2

Total Burner Power – 8.3 kw

Product Size mm (WxDxH) 700 x 520 x 106

Cutting Size mm (WxDxH) 660 x 480 x 50

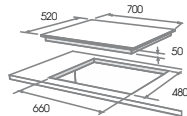

**Enameled Coated Burners**  
**Flexi Hob-Top**





---

MULTI-FLAME CONTROL  
INOX PRO FB SERIES

---

STYLISH, SLIM AND  
ELEGANT, THE NEXT  
CONVERSATION PIECE  
WILL BE STRAIGHT  
OUT OF THE KITCHEN.





## INOX PRO FB SERIES



### INOX PRO FB MFC 3B 75 DX FFD

Built In Stainless Steel Hob - 3 Burner 75 cm  
 Auto Electric Ignition,  
 Round Metallic Knobs  
**Full Brass Heavy Duty Multi-flame burners**  
**Flame Failure Safety Device (FFD)**  
 Ignition Plug with Brass Sleeve  
**5 Years warranty on Glass & Valves**

#### Full Brass Burners :

Heavy Duty Multi-Flame Control Burners – 4 kw x 2  
 Heavy Duty Double Ring Burner - 1.7 kw x 1  
 Total Burner Power – 9.7 kw

Product Size mm (W x D x H) 750 x 450 x 123  
 Cutting Size mm (W x D x H) 710 x 410 x 55

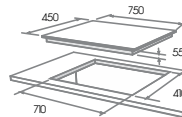

**MULTI-FLAME CONTROL**  
**INOX PRO FB SERIES**



## INOX PRO FB SERIES

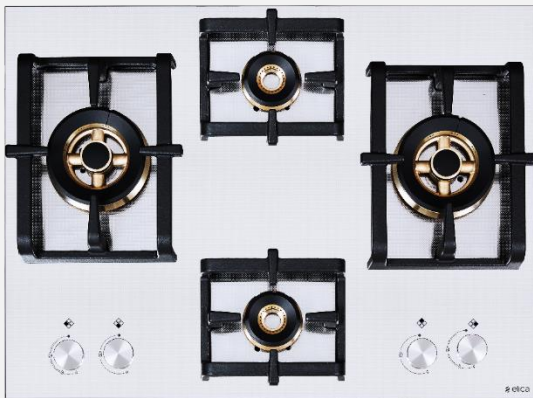

**MULTI-FLAME CONTROL**  
**INOX PRO FB SERIES**



### INOX PRO FB MFC 4B 70 DX FFD

Built In Stainless Steel Hob - 4 Burner 70 cm  
Auto Electric Ignition,  
Round Metallic Knobs  
**Full Brass Heavy Duty Multi-flame burners**  
**Flame Failure Safety Device (FFD)**  
Ignition Plug with Brass Sleeve  
**5 Years warranty on Glass & Valves**

#### **Full Brass Burners :**

Heavy Duty Multi-Flame Control Burners – 4 kw x 2  
Heavy Duty Double Ring Burner - 1.7 kw x 2  
Total Burner Power – 11.4 kw

Product Size mm (W x D x H) 700 x 525 x 123  
Cutting Size mm (W x D x H) 645 x 475 x 55

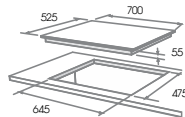

## INOX PRO FB SERIES



MULTI-FLAME CONTROL  
INOX PRO FB SERIES



## INOX PRO FB MFC 4B 91 DX FFD

Built In Stainless Steel Hob - 4 Burner 90 cm  
Auto Electric Ignition,  
Round Metallic Knobs  
**Full Brass Heavy Duty Multi-flame burners**  
**Flame Failure Safety Device (FFD)**  
Ignition Plug with Brass Sleeve  
**5 Years warranty on Glass & Valves**

**Full Brass Burners :**

Heavy Duty Multi-Flame Control Burners – 4 kw x 2  
Heavy Triple Ring Burner – 2.9 kw x 1  
Heavy Duty Double Ring Burner - 1.7 kw x 1  
Total Burner Power – 12.6 kw

Product Size mm (W x D x H) 900 x 525 x 123  
Cutting Size mm (W x D x H) 795 x 485 x 55

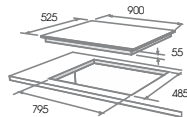



## INOX PRO FB SERIES



MULTI-FLAME CONTROL  
INOX PRO FB SERIES



## INOX PRO FB MFC 5B 90 MT FFD

Built In Stainless Steel Hob - 5 Burner 90 cm  
Auto Electric Ignition,  
Round Metallic Knobs  
**Full Brass Heavy Duty Multi-flame burners**  
**Flame Failure Safety Device (FFD)**  
Ignition Plug with Brass Sleeve  
**5 Years warranty on Glass & Valves**

**Full Brass Burners :**

Heavy Duty Multi-Flame Control Burners – 4 kw x 1  
Heavy Triple Ring Burner – 2.9 kw x 2  
Heavy Duty Double Ring Burner - 1.7 kw x 2  
Total Burner Power – 13.2 kw

Product Size mm (W x D x H) 900 x 525 x 123  
Cutting Size mm (W x D x H) 795 x 485 x 55

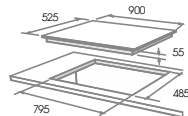



— BUILT-IN MULTIFUNCTION OVENS —

CALL IT AN OVEN  
OR A TANDOOR.  
EITHER WAYS, THE DISH  
WILL BE GRILLED  
JUST RIGHT.







BUILT-IN MULTIFUNCTION  
ELECTRIC OVENS

DO YOUR KEBABS  
A FAVOR  
GRILL THEM  
IN THESE  
ELECTRIC OVENS



## TOUCH CONTROL BUILT-IN OVEN



MULTIFUNCTION BUILT IN  
ELECTRIC OVEN



### EPBI T164 MTC INOX NERO

**60 cm Multifunction Built in Electric Oven with Convection & Rotisserie,**

#### HIGHLIGHTS

- Drop down door with front black stainless steel finish
- Capacitive touch control with LED display
- Net Oven Capacity 72 L
- Maximum power: 3000 watts

#### FEATURES

- Energy efficiency Class A,
- 12 cooking functions
- Easy to clean Enamel Interior Cavity

#### Accessories:

- Rotisserie
- Barbeque skewers

Product Dimension mm (WxDxH) 595 x 575 x 595

Carcase size mm (WxDxH) 560 x 570 x 590

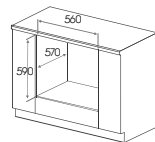

## TOUCH CONTROL BUILT-IN OVEN

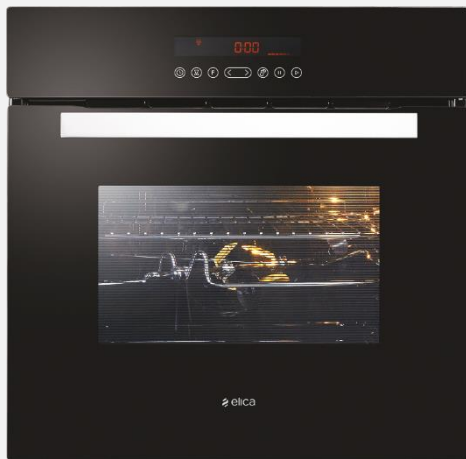

MULTIFUNCTION BUILT IN  
ELECTRIC OVEN



### EPBI T161 MTC BK

**60 cm Multifunction Built in Electric Oven with Convection & Rotisserie,**

#### HIGHLIGHTS

- Drop down door with front black / white glass finish
- Capacitive touch control with LED display
- Net Oven Capacity 70 L
- Maximum power: 3000 watts

#### FEATURES

- Energy efficiency Class A,
- 12 cooking functions
- Easy to clean Enamel Interior Cavity
- Top cooling fan
- Default temperature & adjustable up to 250 degrees
- Halogen lamp, Child lock function
- Electronic clock timer with reminder function
- 3 level adjustable universal pan
- 3 level adjustable wire shelf
- 3 layer full extension telescopic runners
- Energy saving function

Product dimensions: (w x d x h) 595 x 575 x 595 mm

Carcase dimensions: (w x d x h) 560 x 570 x 590 mm

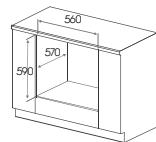

## DIGITAL CONTROL BUILT-IN OVEN



MULTIFUNCTION BUILT IN  
ELECTRIC OVEN



### EPBI 1060 DMF

**60 cm Multifunction Built in Electric Oven with Convection & Rotisserie,**

#### HIGHLIGHTS

- Drop down door with
  - Anti-finger mark stainless steel front
  - Black glass front
- Two rotary pop-up knobs with 4 soft touch electronic controls with LED display.
- Net Oven Capacity 70 L
- Maximum power: 3000 watts

#### FEATURES

- Energy efficiency class - A
- 11 cooking functions
- Rotisserie
- Easy to clean internal enameled cavity
- Top cooling fan • Halogen lamp
- Default temperature & adjustable up to 250 degrees
- • Electronic clock timer with reminder function
- 5 level adjustable universal pan
- 5 level adjustable wire shelf • Child lock function
- Energy saving function

Product dimensions: (w x d x h) 595 x 575 x 595 mm

Carcase dimensions: (w x d x h) 560 x 570 x 590 mm

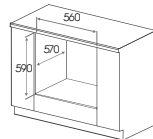

## DIGITAL CONTROL BUILT-IN OVEN



MULTIFUNCTION BUILT IN  
ELECTRIC OVEN



### EPBI 1064 DMF

**60 cm Multifunction Built in Electric Oven with Convection & Rotisserie,**

#### HIGHLIGHTS

- Drop down door with
  - Anti-finger mark stainless steel front
  - Black glass front
- Two rotary pop-up knobs with 4 soft touch electronic controls with LED display.
- Net Oven Capacity 70 L
- Maximum power: 3000 watts

#### FEATURES

- Energy efficiency class - A
- 11 cooking functions
- Rotisserie
- Easy to clean internal enameled cavity
- Top cooling fan • Halogen lamp
- Default temperature & adjustable up to 250 degrees
- • Electronic clock timer with reminder function
- 5 level adjustable universal pan
- 5 level adjustable wire shelf • Child lock function
- Energy saving function

Product dimensions: (w x d x h) 595 x 575 x 595 mm

Carcase dimensions: (w x d x h) 560 x 570 x 590 mm

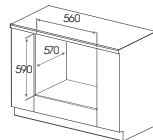



## DIGITAL CONTROL BUILT-IN OVEN



MULTIFUNCTION BUILT IN  
ELECTRIC OVEN



### EPBI 1063

**60 cm Multifunction Built in Electric Oven with  
Convection & Rotisserie,**

#### HIGHLIGHTS

- Drop down door with anti-finger mark stainless steel front
- Two rotary pop-up knobs with 4 soft touch electronic controls with LED display.
- Net Oven Capacity 70 L
- Maximum power: 3000 watts

#### FEATURES

- Energy efficiency Class A
- 11 cooking functions
- Rotisserie
- Easy to clean Enamel Interior Cavity

Product dimensions: (w x d x h) 595 x 575 x 595 mm

Carcase dimensions: (w x d x h) 560 x 570 x 590 mm

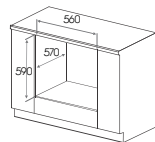

## DIGITAL CONTROL BUILT-IN OVEN



MULTIFUNCTION BUILT IN  
ELECTRIC OVEN



### EPBI 1062 TRIM DMF

**60 cm Multifunction Built in Electric Oven with Convection & Rotisserie,**

#### HIGHLIGHTS

- Drop down door with anti-finger mark stainless steel front
- Two rotary pop-up knobs with 4 soft touch electronic controls with LED display.
- Net Oven Capacity 70 L
- Maximum power: 3000 watts

#### FEATURES

- Energy efficiency class - A
- 11 cooking functions
- Rotisserie
- Easy to clean internal enameled cavity
- Top cooling fan • Halogen lamp
- Default temperature & adjustable up to 250 degrees
- Electronic clock timer with reminder function
- 3 level adjustable universal pan
- 3 level adjustable wire shelf
- 3 layer full extension telescopic runners
- Child lock function • Energy saving function

Product dimensions: (w x d x h) 595 x 575 x 595 mm

Carcase dimensions: (w x d x h) 560 x 570 x 590 mm

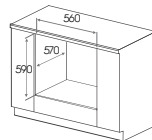

## MECHANICAL CONTROL BUILT-IN OVEN



MULTIFUNCTION BUILT IN  
ELECTRIC OVEN



### EPBI 861 MMF / EPBI 961 MMF

**60 cm Multifunction Built in Electric Oven with Convection.**

#### HIGHLIGHTS

- Drop down door with anti-finger mark stainless steel & black glass front
- Three rotary controls
- Functions knob - Timer knob - Temperature knob
- Net Oven Capacity 65 L
- Maximum power: 3000 watts

#### FEATURES

- Energy efficiency class – A  
saves up to 30%-40% energy in convection fan mode
- 8 cooking functions
- Easy to clean internal enameled cavity
- Top cooling fan
- Default temperature & adjustable up to 250 degrees
- Halogen lamp
- 5 level adjustable universal pan
- 5 level adjustable wire shelf

Product dimensions: (w x d x h) 595 x 575 x 595 mm

Carcase dimensions: (w x d x h) 560 x 570 x 590 mm

**Rotisserie available only on EPBI 961 MMF**

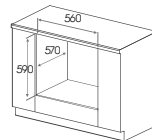

## MECHANICAL CONTROL BUILT-IN OVEN



MULTIFUNCTION BUILT IN  
ELECTRIC OVEN



### EPBI 865 / 965 MMF

**60 cm Multifunction Built in Electric Oven with Convection.**

#### HIGHLIGHTS

- Drop down door with front black / white glass finish
- Capacitive touch control with LED display
- Net Oven Capacity 65 L
- Maximum power: 3000 watts

#### FEATURES

- Energy efficiency class – A  
saves up to 30%-40% energy in convection fan mode
- 8 cooking functions
- Easy to clean internal enameled cavity
- Top cooling fan • Halogen lamp
- Default temperature & adjustable up to 250 degrees
- Electronic clock timer with reminder function
- 3 level adjustable universal pan
- 3 level adjustable wire shelf
- 3 layer full extension telescopic runners
- Energy saving function

Product dimensions: (w x d x h) 595 x 575 x 595 mm

Carcase dimensions: (w x d x h) 560 x 570 x 590 mm

**Rotisserie & 9 cooking functions available only in EPBI 965 MMF**

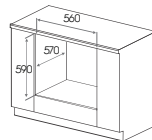

## MECHANICAL CONTROL BUILT-IN OVEN



MULTIFUNCTION BUILT IN  
ELECTRIC OVEN



### EPBI INOX NERO 962 MMF

**60 cm Multifunction Built in Electric Oven with Convection & Rotisserie**

#### HIGHLIGHTS

- Drop down door with anti-finger mark black stainless steel front
- Three rotary controls
  - Functions knob - Timer knob - Temperature knob
- Net Oven Capacity 71 L
- Maximum power: 3000 watts

#### FEATURES

- Energy efficiency class – A
- 8 cooking functions
- Easy to clean internal enameled cavity

#### Accessories:

- Rotisserie
- Barbeque skewers

Product dimensions: (w x d x h) 595 x 575 x 595 mm

Carcase dimensions: (w x d x h) 560 x 570 x 590 mm

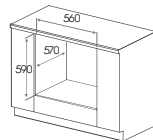



BUILT-IN MULTIFUNCTION ELECTRIC  
COMBINATION OVENS

BAKE. GRILL.  
ROAST. DEFROST. AND  
MICROWAVE TOO.



## BUILT-IN COMBO OVEN + MICROWAVE



MULTIFUNCTION BUILT IN ELECTRIC  
COMBINATION OVEN



### EPBI COMBO OVEN TRIM 44L

60 cm Multifunction Built in Electric Combination Oven

#### HIGHLIGHTS

- Drop down door with anti-finger mark stainless steel
- Two rotary pop-up knobs with 4 soft touch electronic controls with LED display
- Net Oven Capacity 44 L
- Maximum power: 3000 watts
- Rate output power microwave: 900 watts

#### FEATURES

- Energy efficiency class - A  
saves up to 30%-40% energy in convection fan mode
- 13 auto pre-set programs • 5 microwave power levels
- Grill combi with convection
- Memory function • Quick start • Rapid pre-heating
- Easy to clean internal SS cavity • Cooling fan
- Oven lamp • Electronic clock timer
- Child lock function • Energy saving function

#### Accessories:

- Turn table (dia 360 mm)
- Higher wire rack
- Lower wire rack
- Glass baking tray

Product dimensions: (w x d x h) 595 x 570 x 455 mm

Carcase dimensions: (w x d x h) 565 x 560 x 455 mm

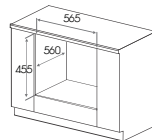

## BUILT-IN COMBO OVEN + MICROWAVE



MULTIFUNCTION BUILT IN ELECTRIC  
COMBINATION OVEN



## EPBI COMBO OVEN 50L

60 cm Multifunction Built in Electric Combination Oven

### HIGHLIGHTS

- Drop down door with anti-finger mark stainless steel
- Two rotary pop-up knobs with 4 soft touch electronic controls with LED display
- Net Oven Capacity 50 L
- Maximum power: 3350 watts
- Rate output power microwave: 900 watts

### FEATURES

- Energy efficiency class - A  
saves up to 30%-40% energy in convection fan mode
- 13 auto pre-set programs • 5 microwave power levels
- Grill combi with convection
- Memory function • Quick start • Rapid pre-heating
- Easy to clean internal SS cavity • Cooling fan
- Oven lamp • Electronic clock timer
- Child lock function • Energy saving function

### Accessories:

- Lower wire rack
- Higher wire rack
- Glass baking tray

Product dimensions: (w x d x h) 595 x 570 x 455 mm

Carcase dimensions: (w x d x h) 565 x 560 x 455 mm

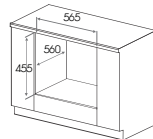



## BUILT-IN COMBO OVEN + STEAM



MULTIFUNCTION BUILT IN ELECTRIC  
COMBINATION OVEN + STEAM



## EPBI COMBO STEAM OVEN 390

60 cm Multifunction Built in Oven with Steam

### HIGHLIGHTS

- Drop down door with anti-finger mark stainless steel
- Two rotary pop-up knobs with 4 soft touch electronic controls with LED display
- Net Oven Capacity 39 L
- Maximum power: 3350 watts
- Rate output power microwave: 900 watts

### FEATURES

- Energy efficiency class - A  
saves up to 30%-40% energy in convection fan mode
- Steam function
- Grill
- Convection plus steam
- 48 auto menu
- Electronic clock
- Cooking end signal
- Short-circuit protection
- Convection
- Fan grill
- 1 ltr water tank
- Defrost
- Combine cooking type
- Overheat protection
- Child lock

### Accessories:

- Turn table (dia 360 mm)
- Higher wire rack
- Lower wire rack
- Glass baking tray

Product dimensions: (w x d x h) 595 x 570 x 455 mm

Carcase dimensions: (w x d x h) 565 x 560 x 455 mm

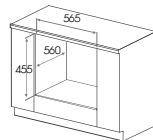



BUILT-IN MULTIFUNCTION  
MICROWAVE OVENS

MICROWAVE OVENS  
WITH STYLE  
AND FUNCTIONALITY  
BUILT-IN





## BUILT-IN MICROWAVE + GRIL



### EPBI MW 220

#### Built In Microwave with Grill

##### HIGHLIGHTS

- Electronic rotary control + soft touch buttons with LED digital display
- Full stainless steel cavity
- Left hinged door
- Right hand side control panel
- Push to open door
- Net oven capacity: 22 L

#### Possible cooking without auto cooking programs

- Microwave cooking • Grill • Microwave + grill

##### FEATURES

- 8 Auto cooking programs
- Quick start
- 5 Microwave Power Levels
- Child Lock function
- Defrost
- 245 mm glass turntable
- Timer

#### Accessories:

- Grill rack

Product dimensions: (w x d x h) 594 x 343.5 x 388 mm

Carcase dimensions: (w x d x h) 564 x 350 x 380 mm

BUILT IN MICROWAVE WITH GRILL

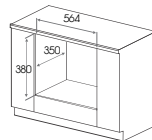

## BUILT-IN MICROWAVE + GRIL

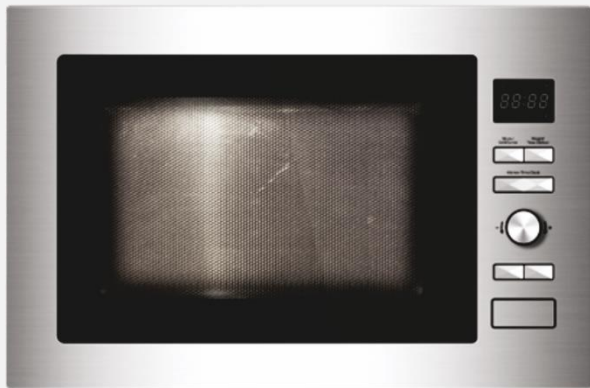

### EPBI MW G25

#### Built In Microwave with Grill

#### HIGHLIGHTS

- Electronic control with LED display
- Full stainless steel cavity
- Left hinged door
- Right hand side control panel
- Push to open door
- Net oven capacity: 25 L

#### Possible cooking without auto cooking programs

- Microwave cooking • Grill • Microwave + grill

#### FEATURES

- Energy efficiency class: A
- 8 Auto cooking programs
- Quick start
- 5 Microwave Power Levels
- Child Lock function
- Defrost
- 315 mm glass turntable
- Timer

#### Accessories:

- Grill rack

Product dimensions: (w x d x h) 595 x 400 x 388 mm

Carcase dimensions: (w x d x h) 564 x 500 x 380 mm

BUILT IN MICROWAVE WITH GRILL

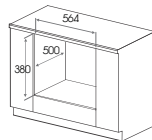

## BUILT-IN MICROWAVE + GRIL



BUILT IN MICROWAVE WITH GRILL



## EPBI MWO G28 TOUCH

### Built In Microwave with Grill

#### HIGHLIGHTS

- Capacitive touch control with LED display
- Full stainless steel cavity
- Left hinged door
- Right hand side control panel
- Push to open door
- Net oven capacity: 28 L

#### Possible cooking without auto cooking programs

- Microwave grill or combi cooking
- Microwave + grill
- Grill + convection
- Microwave + grill + convection
- Convection with preheating function
- Convection cooking without preheating

#### FEATURES

- Energy efficiency class: A
- 10 Auto cooking programs
- Quick start
- 5 Microwave Power Levels
- Child Lock function
- Defrost
- 315 mm glass turntable
- Timer
- Multistage cooking

#### Accessories: • Grill rack

Product dimensions: (w x d x h) 595 x 470 x 388 mm

Carcase dimensions: (w x d x h) 564 x 550 x 380 mm

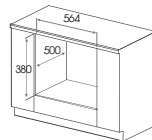

## BUILT-IN MICROWAVE + GRIL



BUILT IN MICROWAVE WITH GRILL



## EPBI MWO G25 INOX NERO

### Built In Microwave with Grill

#### HIGHLIGHTS

- Capacitive touch control with LED display
- Full stainless steel cavity
- Left hinged door
- Right hand side control panel
- Push to open door
- Net oven capacity: 25 L

#### Possible cooking without auto cooking programs

- Microwave cooking • Grill • Microwave + grill

#### FEATURES

- Energy efficiency class: A
- 8 Auto cooking programs
- Quick start
- 5 Microwave Power Levels
- Child Lock function
- Defrost
- 245 mm glass turntable
- Timer
- Multistage cooking

#### Accessories:

- Grill rack

Product Dimensions (W x D x H) 595 x 401 x 388

Carcase Dimensions mm (W x D x H) 564 x 500 x 380

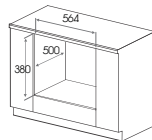

## BUILT-IN MICROWAVE + GRIL



### EPBI MWO GL 220

#### Built In Microwave with Grill

#### HIGHLIGHTS

- Touch control with led display
- Timer, multistage cooking
- Defrost, add 30 sec
- Cooking end signal
- Child lock function
- Net oven capacity: 22 L

#### Possible cooking without auto cooking programs

- Microwave cooking • Grill • Microwave + grill

#### FEATURES

- 8 Auto cooking programs
- Quick start
- Glass turntable
- 5 Microwave Power Levels
- Timer
- Multistage cooking

#### Accessories:

- Grill rack

Product Dimensions mm(W x D x H) 595 x 401 x 388

Carcase Dimensions mm(W x D x H) 564 x 500 x 380

BUILT IN MICROWAVE WITH GRILL

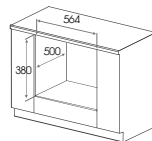



## BUILT-IN MICROWAVE + GRIL + CONVECTION



BUILT IN MICROWAVE WITH GRILL + CONVECTION



### EPBI MW 250

#### Built In Microwave with Grill and convection

##### HIGHLIGHTS

- Electronic rotary control + soft touch buttons with LED digital display
- Full stainless steel cavity
- Left hinged door
- Right hand side control panel
- Push to open door
- Net oven capacity: 25 L

##### Possible cooking without auto cooking programs

- Microwave grill or combi cooking
- Microwave + grill
- Microwave + grill + convection
- Convection with preheating function
- Convection cooking without preheating
- Grill + convection

##### FEATURES

- Energy efficiency class: A
- 10 Auto cooking programs
- 5 Microwave Power Levels
- Timer
- 315 mm glass turntable
- Quick start
- Glass turntable
- Multistage cooking
- Child Lock function

##### Accessories: • Grill rack

Product Dimensions mm(W x D x H) 594 x 470 x 388

Carcase Dimensions mm(W x D x H) 564 x 550 x 380

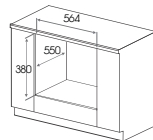

## BUILT-IN MICROWAVE + GRIL + CONVECTION



### EPBI MW 340

#### Built In Microwave with Grill and convection

#### HIGHLIGHTS

- Electronic rotary control + soft touch buttons with LED digital display
- Full stainless steel cavity
- Left hinged door
- Right hand side control panel
- Push to open door
- Net oven capacity: 34 L

#### Possible cooking without auto cooking programs

- Microwave grill or combi cooking
- Microwave + grill
- Microwave + grill + convection
- Convection with preheating function
- Convection cooking without preheating
- Grill + convection

#### FEATURES

- Energy efficiency class: A
- 10 Auto cooking programs
- 5 Microwave Power Levels
- Timer
- 315 mm glass turntable
- Quick start
- Glass turntable
- Multistage cooking
- Child Lock function

#### Accessories: • Grill rack

Product Dimensions mm(W x D x H) 595 x 467.5 x 388

Carcase Dimensions mm(W x D x H) 550 x 550 x 380

BUILT IN MICROWAVE WITH GRILL + CONVECTION

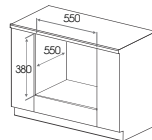

## BUILT-IN MICROWAVE + GRIL + CONVECTION



### EPBI MWO 280 TOUCH BK/WHITE

#### Built In Microwave with Grill and convection

#### HIGHLIGHTS

- Capacitive touch control with LED display
- Full stainless steel cavity
- Right hand side control panel
- Net oven capacity: 28 L
- Left hinged door
- Touch to open door

#### Possible cooking without auto cooking programs

- Microwave grill or combi cooking
- Microwave + grill
- Microwave + grill + convection
- Grill + convection
- Convection with preheating function
- Convection cooking without preheating

#### FEATURES

- Energy efficiency class: A
- 10 Auto cooking programs
- 5 Microwave Power Levels
- Timer
- 315 mm glass turntable
- Quick start
- Glass turntable
- Multistage cooking
- Child Lock function

#### Accessories: • Grill rack

Product Dimensions mm(W x D x H) 595 x 470 x 388

Carcase Dimensions mm(W x D x H) 564 x 550 x 380

BUILT IN MICROWAVE WITH GRILL + CONVECTION

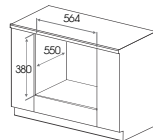

## COMBI PAIRS OF OVEN & MICROWAVE OVEN



EPBI MWO G25 INOX NERO  
+  
EPBI 1164 MTC INOX NERO

EPBI MWO G28 TOUCH  
+  
EPBI 861 MMF/EPBI 961 MMF

EPBI MWO 280 TOUCH BK  
+  
EPBI 1161 BK

EPBI MW G25  
+  
EPBI 1063

EPBI COMBO OVEN TRIM 44 L  
+  
EPBI 1062 TRIM DMF





BUILT-IN  
WARMER DRAWER



## BUILT-IN WARMER DRAWER



### EPBI WD 22L VETRO BK

- Food Warming and Defrosting
- 5 Temperature Setting Level
- Load Bearing - 25kg Max
- Interior Volume - 22L
- 140mm high Warming Drawer
- Capacitive Touch Control
- Cavity - Stainless Steel
- Temperature Range - 40-80 °C
- Bottom heater : 600 W
- Temperature range : 4080 °C
- Maximum number of plates (26 cm) : 12
- Maximum number of espresso cups: 80

Product Size mm (W x D x H) - 595 x 541 x 141  
Carcase Size mm (W x D x H) - 560 x 560 x 146

BUILT IN MICROWAVE WITH GRILL + CONVECTION

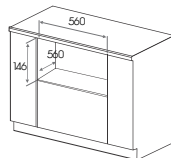

## BUILT-IN WARMER DRAWER



### EPBI WD 22L SS

- Food Warming and Defrosting
- 5 Temperature Setting Level
- Load Bearing - 25kg Max
- Interior Volume - 22L
- 140mm high Warming Drawer
- Capacitive Touch Control
- Cavity - Stainless Steel
- Temperature Range - 40-80 °C
- Bottom heater : 600 W
- Temperature range : 4080 °C
- Maximum number of plates (26 cm) : 12
- Maximum number of espresso cups: 80

Product Size mm (W x D x H) - 595 x 541 x 141  
Carcase Size mm (W x D x H) - 560 x 560 x 146

BUILT IN MICROWAVE WITH GRILL + CONVECTION

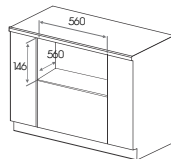



BUILT-IN  
INDUCTION, FRYER & BARBEQUE

SAFER. FASTER.  
MORE EFFICIENT  
EASILY THE  
BEST ASSISTANT  
A CHEF CAN ASK FOR.





## BUILT-IN INDUCTION HOB

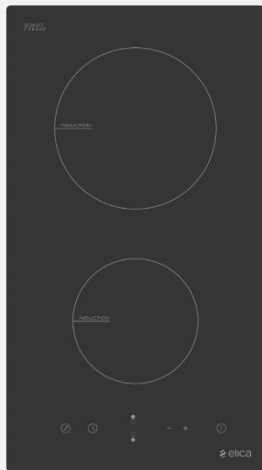

### EIH 2Z 30

- Cooking zones: 2 zones
- Supply voltage: 220/240V~
- Installed electric power: 3500w
- Product size: (w x d x h) 288 x 520 x 56 mm
- Cutting size: (w x d x h) 268 x 500 x 60 mm
- Controls: Touch

#### Functions

- Timer control: A - as a minute minder  
B - to turn one cooking zone off

Heat settings: 9 power setting

Pan sensor: Yes

Automatic

safety switch off: When cooking timer expires, the corresponding cooking zone will be switched o automatically

Residual

heat indicators: Yes

Child lock: Yes

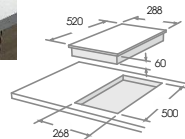

BUILT IN INDUCTION HOB



## BUILT-IN INDUCTION HOB



### EIH 4Z 30

- Cooking zones: 4 zones
- Supply voltage: 220240V~
- Installed electric power: 6400 - 7200 w
- Product size: (w x d x h) 590 x 520 x 60 mm
- Cutting size: (w x d x h) 560 x 490 x 65 mm
- Controls: Touch

#### Functions

- Timer control: A - as a minute minder  
B - to turn one cooking zone off

Heat settings: 9 power setting

Pan sensor: Yes

Automatic

safety switch off: When cooking timer expires, the corresponding cooking zone will be switched o automatically

Residual

heat indicators: Yes

Child lock: Yes

Boost: We can reach to maximum power with this function

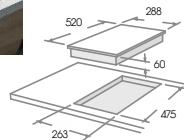

BUILT IN INDUCTION HOB



## BUILT-IN BARBEQUE

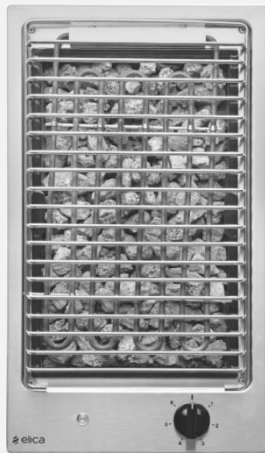

BUILT IN INDUCTION HOB



## BARBEQUE NC30 INOX

- Supply voltage: 220240v~ - 50/60 Hz
- Installed electric power: 2.5 kw
- Accessories: Removable enamelled grid  
Lava stone

Product Size mm (WxDxH) 288 x 500 x 50  
Cutting Size mm (WxDxh) 263 x 475 x 60

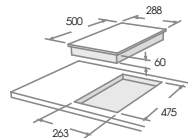
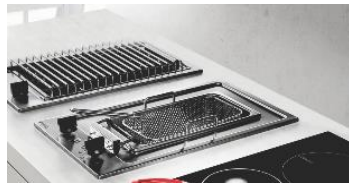

## BUILT-IN FRYER



BUILT IN INDUCTION HOB



## FRYER NC30 INOX

- Supply voltage: 220240V~ - 50/60 Hz
- Installed electric power: 1.6 kw
- Accessories: A stainless steel basin with handles for easy lifting and cleaning  
A chromium steel wire basket with folding handles  
A protecting lid

Product Size mm (WxDxH) 288 x 500 x 120

Cutting Size mm (WxDxh) 263 x 475 x 160

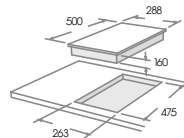
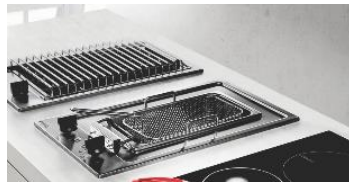



COOKING  
RANGE

ALL YOUR  
COOKING NEEDS  
MET BY  
ONE APPLIANCE.



## FREE STANDING COOKING RANGE



### F 9502 XGRH

#### Features:

- European CE - CB standard
  - Two triple ring, one rapid, one semi rapid and one auxiliary burners
  - Single pc oven cavity for better performance
  - Oven capacity: 110 L
  - Oven and grill with thermostatic valve control with safety device
  - Rotisserie to heat the food uniformly from all sides
  - Timer
  - oven lamp
  - Cast iron grids
  - Top hob and front with 304 stainless steel
  - Toughened top glass lid
  - Full auto ignition
- 
- Accessories: wire rack, wok grill and enameled tray
  - Adjustable legs

Product dimensions: (w x d x h) 900 x 610 x 925 mm



FREE STANDING COOKING RANGE



## FREE STANDING COOKING RANGE



### F 6402 ZGRH

#### Features:

- European CE - CB standard
- One triple ring, two semi rapid and one auxiliary burner
- Single pc oven cavity for better performance
- Oven capacity: 54 L
- Oven and grill with thermostatic valve control with safety device
- Rotisserie to heat the food uniformly from all sides
- Timer
- oven lamp
- Enamelled grids
- Top hob and front with 304 stainless steel
- Toughened top glass lid
- Push button auto ignition
- Accessories:
  - wire rack
  - wok grill and enameled tray
- Adjustable legs

Product dimensions: (w x d x h) 600 x 630 x 855 mm



FREE STANDING COOKING RANGE



## FREE STANDING COOKING RANGE



### F 3402 WGVH SS

#### Features:

- European CE - CB standard
- One rapid, Two semi rapid and one auxiliary burner
- Single pc oven cavity for better performance
- Oven capacity: 52 L
- Oven and grill with thermostatic valve control with safety device
- Timer
- oven lamp
- Enamelled grids
- Top hob and front with 304 stainless steel
- Toughened top glass lid
- Push button auto ignition
- Accessories:
  - Oven wire grid and enameled tray
- Adjustable legs

Product dimensions: (w x d x h) 500 x 550 x 855 mm



FREE STANDING COOKING RANGE





## FREE STANDING COOKING RANGE



### F 3402 NGRB BK

#### Features:

- European CE - CB standard
- One rapid, Two semi rapid and one auxiliary burner
- Single pc oven cavity for better performance
- Oven capacity: 52 L
- Oven and grill with thermostatic valve control with safety device
- Enamelled grids
- Top hob and front with 304 stainless steel
- Toughened top glass lid
- Push button
- Accessories:
  - Wire rack, wok grill and enameled tray
- Adjustable legs

Product dimensions: (w x d x h) 500 x 550 x 855 mm



FREE STANDING COOKING RANGE





BUILT-IN  
DISHWASHERS

KEEP YOUR  
DISHES AND VESSELS  
SPICK AND SPAN,  
HOWEVER OILY THE FOOD.  
AFTER ALL,  
CLEANLINESS IS GOD.





## BUILT-IN DISHWASHER



### WQP 12 - 7735 HR

#### Features:

- 60 cm semi-integrated
- 3 layer cutlery drawer
- Half load
- Soft touch LED control
- Extra drying / power wash / express
- Hidden heating element
- Pocket handle

#### Specifications:

- A++ energy efficiency class
- 6 wash programmes:  
Intensive • Normal • Eco  
Glass • 90 min • Rapid
- 14 plate settings
- Delay timer: 3 / 6 / 9 / 12 hours

Product dimensions: (w x d x h) 598 x 600 x 815 mm

Carcase dimensions: (w x d x h) 600 x 580 x 820 mm

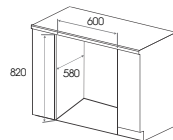

BUILT-IN DISHWASHER



## BUILT-IN DISHWASHER



### WQP 12 - 7711

#### Features:

- 60 cm fully-integrated
- Half load
- Soft touch electronic control
- Hidden heating element

#### Specifications:

- A++ energy efficiency class
- 6 wash programmes:  
Intensive • Normal • Eco  
Glass • 90 min • Rapid
- 12 plate settings
- Delay timer: 3 / 6 / 9 hours

Product Dimensions mm (W x D x H) 598 x 550 x 815

Carcase Dimensions mm (W x D x H) 600 x 580 x 820

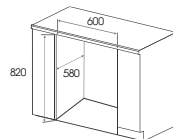

BUILT-IN DISHWASHER



## BUILT-IN DISHWASHER

### WQP 12 - 7713 M

#### Features:

- 60 cm fully-integrated
- 3 layer cutlery drawer
- Half load
- Soft touch control with LED display
- Extra drying / power wash / express
- Hidden heating element

#### Specifications:

- A++ energy efficiency class
- 8 wash programmes:  
Auto • Intensive • Normal • Eco  
Glass • 90 min • Rapid • Soak
- 14 plate settings
- 124 hours delay start
- Optional front door

Product Dimensions mm (W x D x H) 598 x 600 x 815

Carcase Dimensions mm (W x D x H) 600 x 550 x 815

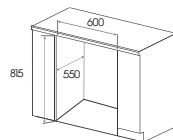

BUILT-IN DISHWASHER



## FREE STANDING DISHWASHER



### WQP 12 - 7605V WH

#### Features:

- 60 cms free standing
- Half load
- Soft touch electronic control
- Hidden heating element
- Pocket handle
- White LED displays (2 displays Integrated is for operating & front LED display for monitoring wash cycle)

#### Specifications:

- A++ energy efficiency class
- 5 wash programmes:  
1 hour • Intensive • Eco  
Quick • Soak
- 12 plate settings

Product dimensions: (w x d x h) 598 x 600 x 845 mm

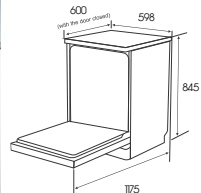

FREE STANDING DISHWASHER



## FREE STANDING DISHWASHER



### WQP 12 - 7605V SS

#### Features:

- 60 cms free standing
- Half load
- Soft touch electronic control
- Hidden heating element
- Pocket handle
- White LED displays (2 displays Integrated is for operating & front LED display for monitoring wash cycle)

#### Specifications:

- A++ energy efficiency class
- 5 wash programmes:  
1 hour • Intensive • Eco  
Quick • Soak
- 12 plate settings

Product dimensions: (w x d x h) 598 x 600 x 845 mm

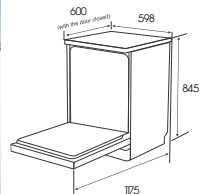

FREE STANDING DISHWASHER







COOKTOPS

HOME IS  
WHERE  
THE  
HEARTH IS.





## TOP KNOB SERIES



DUAL TONE  
TOUGHENED GLASS



FORGED  
BRASS BURNERS



EUROPEAN  
GAS VALVES



DESIGNER  
BAKELITE KNOBS



CROWN SHAPE EURO-  
COATED PAN SUPPORT



DOUBLE DRIP TRAY



## TOP KNOB COOKTOP



### 773 CT VETRO (TKN CROWN DT SERIES)

- Top knob Glass Cooktop - 3 Burner 75 cm
- Forged Brass Burner
- Ultra Slim Frame
- Burners - 1 Jumbo, 1 Medium, 1 Small
- Crown Shape Euro Coated Pan Support
- Designer Bakelite Knobs
- European Gas Valves
- Dual Tone Toughened Glass
- **Five Years Warranty on Glass, Burners & Gas Valves**
- Product Size mm (W x D) 750 x 455



FORGED BRASS BURNERS COOKTOP



HOME

## TOP KNOB COOKTOP



### 694 CT VETRO 2J (TKN CROWN DT SERIES)

- Top knob Glass Cooktop - 4 Burner 70 cm
- Forged Brass Burner
- Ultra Slim Frame
- Burners - 2 Jumbo, 1 Medium, 1 Small
- Crown Shape Euro Coated Pan Support
- Designer Bakelite Knobs
- European Gas Valves
- Dual Tone Toughened Glass
- **Five Years Warranty on Glass, Burners & Gas Valves**
- Product Size mm (W x D) 700 x 560



FORGED BRASS BURNERS COOKTOP



## TOP KNOB COOKTOP

### 904 CT VETRO 2J (TKN CROWN DT SERIES)

- Top knob Glass Cooktop - 4 Burner 88 cm
- Forged Brass Burner
- Ultra Slim Frame
- Burners - 2 Jumbo, 1 Medium, 1 Small
- Crown Shape Euro Coated Pan Support
- Designer Bakelite Knobs
- European Gas Valves
- Dual Tone Toughened Glass
- **Five Years Warranty on Glass, Burners & Gas Valves**
- Product Size mm (W x D) 880 x 525



FORGED BRASS BURNERS COOKTOP





## SLIMLINE SPF SERIES



BLACK  
TOUGHENED GLASS



EUROCOATED HEAVY DUTY  
SQUARE PAN SUPPORTS



FORGED  
BRASS BURNERS



ULTRA SLIM  
FRAME

SLIMLINE SPF SERIES FRAME



## SLIMLINE SPF SERIES COOKTOP



### 773 CT VETRO (SLIMLINE SPF)

- Slim Line SPF Glass Cooktop
- 3 Burners 77 cm
- Heavy Duty Forged Brass Burners
- Burners: 1 Jumbo, 1 Medium, 1 Small
- Black Toughened Glass
- Ultra Slim Frame
- Grids: Square Eurocoated
- **Seven Years Warranty on Glass**
- **Five Years Warranty on Burners**
  
- Product Size mm (W x D) 770 x 470



BLACK  
TOUGHENED GLASS



EUROCOATED HEAVY DUTY  
SQUARE PAN SUPPORTS



FORGED  
BRASS BURNERS



HEAVY DUTY FORGED BRASS BURNERS COOKTOP



## SLIMLINE SPF SERIES COOKTOP



### 694 CT VETRO (SLIMLINE SPF)

- Slim Line SPF Glass Cooktop
- 4 Burners 69 cm
- Heavy Duty Forged Brass Burners
- Burners: 2 Jumbo, 1 Medium, 1 Small
- Black Toughened Glass
- Ultra Slim Frame
- Grids: Square Eurocoated
- **Seven Years Warranty on Glass**
- **Five Years Warranty on Burners**
  
- Product Size mm (W x D) 690 x 550



BLACK  
TOUGHENED GLASS



EUROCOATED HEAVY DUTY  
SQUARE PAN SUPPORTS



FORGED  
BRASS BURNERS



HEAVY DUTY FORGED BRASS BURNERS COOKTOP



HOME





PATIO SPF SERIES



## PATIO SPF SERIES COOKTOP



### PATIO ICT 773 BLK (SPF SERIES)

- Glass Cooktop with Jumbo Burner
- 3 Burners 77 cm
- Heavy Duty Forged Brass Burners
- Burners: 1 Jumbo, 1 Medium, 1 Small
- Black Toughened Glass
- Ultra Slim Frame
- Grids: Square
- **Seven Years Warranty on Glass**
- **Five Years Warranty on Gas Valves & Burners**
  
- Product Size mm (W x D) 770 x 470



HEAVY DUTY FORGED BRASS BURNERS COOKTOP



## PATIO SPF SERIES COOKTOP



HEAVY DUTY FORGED BRASS BURNERS COOKTOP



## PATIO ICT 469 BLK S (SPF SERIES)

- Glass Cooktop with Jumbo Burner
- 4 Burners 69 cm
- Heavy Duty Forged Brass Burners
- Burners: 2 Jumbo, 1 Medium, 1 Small
- Black Toughened Glass
- Ultra Slim Frame
- Grids: Square
- **Seven Years Warranty on Glass**
- **Five Years Warranty on Gas Valves & Burners**
- Product Size mm (W x D) 690 x 570





DT (DOUBLE DRIP TRAY) SERIES

DOUBLE  
DRIP TRAY  
ASSEMBLY



PAN SUPPORT  
REMOVABLE DRIP TRAY  
FIXED DRIP TRAY



## DT (DOUBLE DRIP TRAY) SERIES COOKTOP



### 773 CT VETRO (DT SERIES)

- **Double Drip Tray Glass Cooktop with Jumbo Burner**
- 3 Burners 77 cm
- Black toughened glass
- Brass Burners: 1 Jumbo, 1 Medium, 1 Small
- Grids - Round Eurocoated
- Auto Ignition - Optional
- **Seven Years Warranty on Glass**
  
- Product Size mm (W x D) 770 x 470



DOUBLE DRIP TRAY WITH JUMBO BURNER  
GLASS COOKTOP



## DT (DOUBLE DRIP TRAY) SERIES COOKTOP

### 694 CT VETRO (DT SERIES)

- **Double Drip Tray Glass Cooktop with Jumbo Burner**
- 4 Burners 69 cm
- Black toughened glass
- Brass Burners: 1 Jumbo, 1 Medium, 2 Small
- Grids - Round Eurocoated
- Auto Ignition - Optional
- **Seven Years Warranty on Glass**
  
- Product Size mm (W x D) 690 x 570



DOUBLE DRIP TRAY WITH JUMBO BURNER  
GLASS COOKTOP



## DT (DOUBLE DRIP TRAY) SERIES COOKTOP



DOUBLE DRIP TRAY WITH JUMBO BURNER  
GLASS COOKTOP



### 594 CT VETRO 1J (DT SERIES)

- **Double Drip Tray Glass Cooktop with Jumbo Burner**
- 4 Burners 59 cm
- Black toughened glass
- Brass Burners: 1 Jumbo, 1 Medium, 2 Small
- Grids - Round Eurocoated
- Auto Ignition - Optional
- **Seven Years Warranty on Glass**
  
- Product Size mm (W x D) 585 x 560



## DT (DOUBLE DRIP TRAY) SERIES COOKTOP



DOUBLE DRIP TRAY WITH JUMBO BURNER  
GLASS COOKTOP



## PATIO ICT 773 SS (DT SERIES)

- **Double Drip Tray Glass Cooktop**
- 3 Burners 77 cm
- Black toughened glass
- Brass Burners: 1 Large, 1 Medium, 1 Small
- Grids - Round Eurocoated
- Auto Ignition - Optional
- **Also available with Black / Orange frame**
- Product Size mm (W x D) 770 x 470





## DT (DOUBLE DRIP TRAY) SERIES COOKTOP



DOUBLE DRIP TRAY WITH JUMBO BURNER  
GLASS COOKTOP



## PATIO ICT 469 BLK S (DT SERIES)

- **Double Drip Tray Glass Cooktop**
- 4 Burners 60 cm
- Black toughened glass
- Brass Burners: 1 Large, 1 Medium, 2 Small
- Grids - Round Eurocoated
- Auto Ignition - Optional
- Product Size mm (W x D) 690 x 570



## DT (DOUBLE DRIP TRAY) SERIES COOKTOP



DOUBLE DRIP TRAY WITH JUMBO BURNER  
GLASS COOKTOP



## PATIO ICT 460 BLK S (DT SERIES)

### • Double Drip Tray Glass Cooktop

- 4 Burners 60 cm
- Black toughened glass
- Brass Burners: 2 Medium, 2 Small
- Grids - Round Eurocoated
- Auto Ignition - Optional
- Product Size mm (W x D) 585 x 570





VETRO SERIES

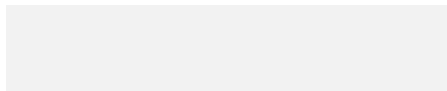

## VETRO SERIES COOKTOP

### 662 CT VETRO

- 2 Burners 66 cm
- Black toughened glass
- Brass Burners: 1 Medium, 1 Small
- Grids - Round Eurocoated
- Auto Ignition - Optional
  
- Product Size mm (W x D) 660 x 340



BRASS BURNER GLASS COOKTOP



## VETRO SERIES COOKTOP

### 703 CT VETRO BK

- 3 Burners 70 cm
- Black toughened glass
- Brass Burners: 2 Medium, 1 Small
- Grids - Round Eurocoated
- Auto Ignition - Optional
  
- Product Size mm (W x D) 700 x 410



BRASS BURNER GLASS COOKTOP



## VETRO SERIES COOKTOP

### 703 CT VETRO SS

- 3 Burners 70 cm
- Black toughened glass
- Brass Burners: 2 Medium, 1 Small
- Grids - Round Eurocoated
- Auto Ignition - Optional
  
- Product Size mm (W x D) 700 x 410



BRASS BURNER GLASS COOKTOP



## VETRO SERIES COOKTOP



### 594 CT VETRO BK

- 4 Burners 60 cm
- Black toughened glass
- Brass Burners: 2 Medium, 1 Small
- Grids - Round Eurocoated
- Auto Ignition - Optional
  
- Product Size mm (W x D) 585 x 560



BRASS BURNER GLASS COOKTOP





INOX (STAINLESS STEEL)  
SERIES





## INOX (STAINLESS STEEL) SERIES COOKTOP

### INOX 753 SS

- 3 Burners 75 cm
- Stainless Steel Finish
- Brass Burners: 1 Large, 1 Medium, 1 Small
- Grids - Round Eurocoated
- Product Size mm (W x D) 730 x 450



BRASS BURNER STAINLESS STEEL COOKTOP



## INOX (STAINLESS STEEL) SERIES COOKTOP

### INOX 604 SS

- 4 Burners 60 cm
- Stainless Steel Finish
- Brass Burners: 2 Medium, 2 Small
- Grids - Round Eurocoated
- Product Size mm (W x D) 590 x 500



BRASS BURNER STAINLESS STEEL COOKTOP



**THANK YOU**